



EurotestAT

MI 3101

Instruction manual

Version UK 4.1, HW5, Code no. 20 751 320

Distributor:

Manufacturer:

METREL d.d.
Ljubljanska cesta 77
1354 Horjul
Slovenia
web site: <http://www.metrel.si>
e-mail: metrel@metrel.si



Mark on your equipment certifies that this equipment meets the requirements of the EU (European Union) concerning safety and electromagnetic compatibility regulations

© 2006..2010 METREL

No part of this publication may be reproduced or utilized in any form or by any means without permission in writing from METREL.

1	Preface	6
2	Safety and operational considerations	7
2.1	Warnings and notes.....	7
2.2	Battery and charging	10
2.2.1	New battery cells or cells unused for a longer period.....	11
2.3	Standards applied.....	12
3	Instrument description	13
3.1	Front panel	13
3.2	Connector panel	14
3.3	Back panel.....	15
3.4	Bottom	16
3.5	Display organization	17
3.5.1	Terminal voltage monitor.....	17
3.5.2	Menu line.....	18
3.5.3	Message field	18
3.5.4	Result field – tests	19
3.5.5	Result field – inspections.....	19
3.5.6	Other messages	19
3.5.7	Sound warnings.....	19
3.5.8	Help	19
3.5.9	Backlight and contrast adjustments.....	20
3.6	Carrying the instrument	21
3.7	Instrument set and accessories	21
3.7.1	Standard set.....	21
3.7.2	Optional accessories	21
4	Instrument operation	22
4.1	Main menu.....	22
4.2	Single test / Inspection	23
4.3	Automatic testing	25
4.3.1	Auto sequence number main menu	26
4.3.2	Auto sequence set.....	27
4.3.3	Test parameters in auto sequence.....	28
4.3.4	Name and description of auto sequence.....	29
4.3.5	Storing auto sequence settings (sequence, number, name).....	30
4.3.6	Pause flag and comments in auto sequence	31
4.3.7	Setting pause flag and comments	31
4.3.8	Building an auto sequence	33
4.4	Miscellaneous.....	37
4.4.1	Language	37
4.4.2	Supply system, Isc factor, RCD standard.....	38
4.4.3	Memory	40
4.4.4	Date and time	40
4.4.5	Initial settings.....	40
4.4.6	Communication port	43
4.4.7	Locator	43
4.4.8	Operator	43
5	Measurements	45
5.1	Inspections	45
5.2	Insulation resistance.....	47
5.3	General resistance measurements (including continuity of star circuit connections).....	50
5.3.1	Compensation of test leads resistance	51

5.3.2	General 200 mA measurement	53
5.3.3	7 mA resistance measurement.....	55
5.3.4	Star circuit resistance R2 measurement	56
5.3.5	Star circuit R1+R2 measurement	58
5.4	Continuity in ring final circuits	60
5.4.1	Ring circuit resistance R1+R2 measurement.....	61
5.4.2	R1+RN measurement.....	64
5.4.3	Auto measurement	66
5.5	Polarity	69
5.6	Testing RCDs	70
5.6.1	Contact voltage (RCD U _c).....	71
5.6.2	Trip-out time (RCD t).....	72
5.6.3	Trip-out current (RCD I _Δ)	73
5.6.4	RCD Autotest	74
5.7	Fault loop impedance and prospective fault current	76
5.8	Line impedance / prospective short-circuit current and Voltage drop	79
5.8.1	Line impedance and prospective short circuit current	80
5.8.2	Voltage drop	81
5.9	Voltage, frequency and phase sequence	83
5.10	Resistance to earth.....	85
5.10.1	Specific earth resistance measurement	86
5.11	2 Ω line/loop impedance.....	88
5.12	PE test terminal	91
5.13	Locator	93
5.14	Varistor test	95
6	Data handling	97
6.1	Memory organization	97
6.2	Installation data structure	97
6.3	Storing test results.....	100
6.3.1	Saving results specialties	100
6.4	Recalling test results and parameters	101
6.4.1	Recalling result.....	101
6.5	Clearing saved data.....	103
6.5.1	Clearing specialties	104
6.6	Editing installation data structure.....	105
6.6.1	Adding new locations	105
6.7	Communication.....	107
7	Maintenance	108
7.1	Replacing fuses	108
7.2	Cleaning	108
7.3	Periodic calibration	108
7.4	Service	108
8	Technical specifications.....	109
8.1	Insulation resistance.....	109
8.2	Continuity	110
8.2.1	Resistance General 200mA, R2, R1+R2.....	110
8.2.2	Resistance General 7mA	110
8.3	Ring Continuity, Polarity	110
8.4	RCD testing	111
8.4.1	General data.....	111
8.4.2	Contact voltage RCD-U _c	111
8.4.3	Trip-out time	111

8.4.4	Trip-out current.....	112
8.5	Fault loop impedance and prospective fault current.....	112
8.5.1	No disconnecting device or FUSE selected.....	112
8.5.2	RCD selected.....	113
8.6	Line impedance / prospective short-circuit current and Voltage drop.....	113
8.7	Voltage, frequency, and phase rotation.....	114
8.7.1	Phase rotation.....	114
8.7.2	Voltage.....	114
8.7.3	Frequency.....	114
8.8	Online terminal voltage monitor.....	114
8.9	Earth resistance.....	114
8.10	2 Ω line/loop impedance.....	115
8.10.1	High precision line impedance.....	115
8.10.2	High precision fault loop impedance.....	116
8.10.3	Contact voltage.....	117
8.11	Varistor test.....	117
8.12	General data.....	118
A	Appendix A - Fuse table.....	119
A.1	Fuse table - IPSC.....	119
A.2	Fuse table - impedances (UK).....	121
B	Appendix B - Accessories for specific measurements.....	123
C	Appendix C – Locator receiver R10K.....	124
C.1	Tracing principles.....	125
C.1.1	Positioning the receiver.....	125
C.1.2	Positioning current clamp.....	125
C.1.3	Positioning selective probe.....	126
C.2	Detection distances for different connections.....	126
C.3	R10K power supply.....	126
C.4	Maintenance.....	126
D	Appendix D - IT supply systems.....	127
D.1	Standard references.....	127
D.2	Fundamentals.....	127
D.3	Measurement guides.....	128
D.3.1	MI 3101 test functions and IT systems.....	129
E	Appendix E - Reduced low voltage supply systems.....	130
E.1	Standard reference.....	130
E.2	Fundamentals.....	130
E.3	MI 3101 guides.....	130
E.3.1	MI 3101 functions and reduced low voltage systems.....	131
E.4	Technical specifications.....	133
E.4.1	RCD.....	133
E.4.2	Fault loop impedance and prospective short-circuit current.....	134
E.4.3	Line impedance and prospective short-circuit current.....	136

1 Preface

Congratulations on your purchase of the instrument and its accessories from METREL. The instrument was designed on basis of rich experience, acquired through many years of dealing with electric installation test equipment.

The multifunctional hand-held installation tester EurotestAT is intended for all tests and measurements required for total inspection of electrical installations in buildings. In general the following measurements and tests can be performed:

- ❑ True rms voltage and frequency, phase sequence,
- ❑ Insulation resistance,
- ❑ Resistance to earth connection and equipotential bonding plus continuous resistance measurement,
- ❑ Line impedance / Voltage drop,
- ❑ Loop impedance,
- ❑ 2 Ω line/loop impedance
- ❑ RCD protection,
- ❑ Resistance to earth,
- ❑ Tracing the installation
- ❑ Overvoltage protection devices,
- ❑ Specific earth resistance measurement.

Tests can be performed on the following supply systems:

- ❑ TN / TT,
- ❑ IT,
- ❑ 110 V reduced low voltage (2 x 55 V) and
- ❑ 110 V reduced low voltage (3 x 63 V).

Beside typical functions as known from standard installation testers, the instrument includes additional functions:

- ❑ Visual inspections of electrical installation as proposed by BS regulations.
- ❑ Continuity tests between N and PE in TN systems can be performed while mains voltage is on.
- ❑ Continuity test modes for ring final circuits.
- ❑ Polarity test.

The high-resolution graphic display with backlight offers easy reading of results, indications, measurement parameters, and messages. Operation is simple and clear – operator does not need any special training (except reading this instruction manual) to operate the instrument.

In order for operator to be familiar enough with measurements in general and their typical applications it is advisable to read Metrel handbook *Measurements on electric installations in theory and practice*.

The instrument is equipped with all accessories necessary for comfortable testing. It is kept in a soft carrying bag together with all accessories.

2 Safety and operational considerations

2.1 Warnings and notes

In order to reach high level of operator's safety while carrying out various tests and measurements using EurotestAT, as well as to keep the test equipment undamaged, it is necessary to consider the following general warnings:

- ❑  **Warning on the instrument means »Read the Instruction manual with special care to safety operation«. The symbol requires an action!**
- ❑ **If the test equipment is used in a manner not specified in this user manual the protection provided by the equipment might be impaired!**
- ❑ **Read this user manual carefully, otherwise use of the instrument may be dangerous for the operator, for the instrument or for the equipment under test!**
- ❑ **Do not use the instrument and accessories if any damage is noticed!**
- ❑ **In case a fuse has blown follow the instructions in this manual to replace it!**
- ❑ **Consider all generally known precautions in order to avoid risk of electric shock while dealing with hazardous voltages!**
- ❑ **Do not use the instrument in supply systems with voltages higher than 550 V!**
- ❑ **Service intervention or adjustment and calibration procedure is allowed to be carried out only by a competent authorized person!**
- ❑ **Use only standard or optional test accessories supplied by your distributor!**
- ❑ **Consider that older and some of new optional test accessories compatible with this instrument meet overvoltage category CAT III / 300 V! It means that maximum allowed voltage between test terminals and ground is 300 V!**
- ❑ **Instrument contains rechargeable NiCd or NiMh battery cells. The cells should only be replaced with the same type as defined on the battery placement label or in this manual. Do not use standard alkaline battery cells while power supply adapter is connected, otherwise they may explode!**
- ❑ **Hazardous voltages exist inside the instrument. Disconnect all test leads, remove the power supply cable and switch off the instrument before removing battery compartment cover.**
- ❑ **All normal safety precautions have to be taken in order to avoid risk of electric shock when working on electrical installations!**

 **Warnings related to measurement functions:**

Insulation resistance

- ❑ **Do not touch the test object during the measurement or before it is fully discharged! Risk of electric shock!**
- ❑ **Automatic discharge of capacitive object will take some time after the finished insulation resistance measurement. Warning message  and actual voltage is displayed during discharging until voltage drops below 10 V. In no case you should disconnect test leads until tested object is completely discharged!**

Notes related to measurement functions:**General**

- ❑ Indicator  means that the selected measurement can't be performed because of irregular conditions on input terminals.
- ❑ Insulation resistance, varistor test, continuity functions and earth resistance measurements shall be performed on de-energized objects, i.e. voltage between test terminals should be lower than 10 V!
- ❑ PASS / FAIL indication is enabled when limit is set to ON. Apply appropriate limit value for evaluation of measurement results.
- ❑ In case that only two of three wires are connected to test electrical installation, only voltage indication between these two wires is valid.

Insulation resistance

- ❑ When measuring insulation resistance between installation conductors all loads must be disconnected and all switches closed!
- ❑ The instrument automatically discharge tested object after finished measurement.
- ❑ Keep the TEST key pressed for continuous measurement.

Continuity functions

- ❑ Parallel resistance paths and interfering currents in measured circuit will influence the test result!
- ❑ If necessary compensate test lead resistance before performing continuity measurement, see 5.2.3.
- ❑ Measuring the resistance of wire wound components like transformer or motor windings is possible only in sub-function (**General 7mA**) due to great influence of the winding inductance.
- ❑ The General 7mA function does not conform to EN61557 eg. BS7671 regulations!

RCD functions

- ❑ Parameters set in one function are also kept for other RCD functions.
- ❑ The measurement of contact voltage will not trip-out RCD of tested installation if selected rated test current is the same as rated $I_{\Delta N}$ of observed RCD. However, the RCD trip-out may occur and U_c measurement is affected as a result of PE leakage currents caused by appliances that are connected to the tested installation.
- ❑ The RCD trip-out current test and U_c measurement could be affected as a result of potential fields of other earthing installations.
- ❑ RCD trip-out current and time will be measured only if pretest of those functions gives contact voltage lower than the selected conventional limit contact voltage.
- ❑ L and N test terminals are reversed automatically according to detected terminal voltage.
- ❑ In case the RCD trips-out during safety pretests it is possible to continue measurements just by recovering the RCD. Possible reasons for trip-out are incorrect RCD sensitivity ($I_{\Delta N}$) selected, relatively high leakage currents in tested installations or defective RCD.

Z-LOOP

- ❑ Fault loop impedance measurement (protection: FUSE or no protection ---) trips-out the RCD. Use the **Z-LOOP Impedance, Protection: RCD** option to prevent the trip-out.
- ❑ **Fault loop impedance** function with selected RCD protection takes longer time to complete but offers much better accuracy than R_L sub-result in **RCD: Uc** function.
- ❑ L and N test terminals are reversed automatically according to detected terminal voltage.

Z-LINE / Voltage drop

- ❑ Measurement of $Z_{Line-Line}$ with the instrument test leads PE and N connected together will generate warning of dangerous PE voltage when the **TEST** key is touched but measurement is not prohibited.
- ❑ L and N test terminals are reversed automatically according to detected terminal voltage.

Earth resistance

- ❑ High currents and voltages in earthing could influence the measurement results.
- ❑ High resistance of S and H probes could influence the measurement results. In this case, indications R_p and R_c appear in the message field. There is no pass / fail indication in this case.
- ❑ Resistance of E measuring wire is added to the measurement result of resistance to earth. Use only standard test accessory without extension lead for E probe.

Line tracer

- ❑ Receiver R10K should always be in IND mode when working with the MI 3101 instrument.
- ❑ When dealing with complex installations (long conductors or more current loops connected in parallel), it is advisable to disconnect parts of the installation that are not of interest at that moment. Otherwise the test signal will spread all over the installation and the selectivity can fall to an unacceptable level.

2.2 Battery and charging

The instrument uses six AA size alkaline or rechargeable Ni-Cd or Ni-MH battery cells. Nominal operating time is declared for cells with nominal capacity of 2100 mAh. Battery condition is always present on the display when the instrument is turned on. In case the battery is weak the instrument indicates this as shown in figure 2.1. This indication appears for a few seconds and then the instrument is turned off.

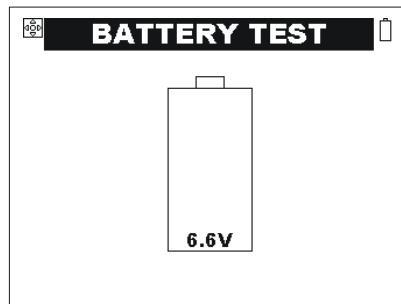

Figure 2.1: Discharged battery indication

The battery is charged whenever the power supply adapter is connected to the instrument. Internal circuit controls charging assuring maximum battery lifetime. Power supply socket polarity is shown in figure 2.2.



Figure 2.2: Power supply socket polarity

The instrument automatically recognizes connected power supply adapter and controls charging.

Symbols:

	Indication of battery charging
7.2	Battery voltage

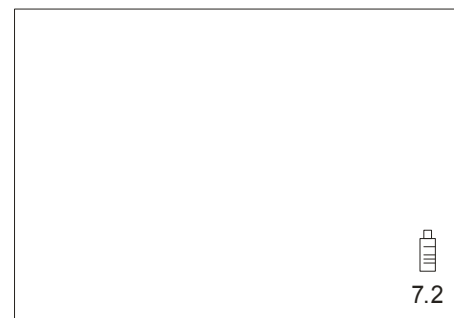



Figure 2.3: Charging indication

- ❑  Before opening battery / fuse compartment cover disconnect all measuring accessories connected to the instrument and power off the instrument.
- ❑ Insert cells correctly, otherwise the instrument will not operate and the batteries could be discharged.
- ❑ If the instrument is not used for longer period remove all battery cells from the battery compartment.
- ❑ Do not charge alkaline battery cells!

- ❑ Take into account handling, maintenance and recycling requirements that are defined by related regulations and manufacturer of alkaline or rechargeable batteries!
- ❑ Use only power supply adapter delivered from manufacturer or distributor of the test equipment to avoid possible fire or electric shock!

2.2.1 New battery cells or cells unused for a longer period

Unpredictable chemical processes can occur during charging of new battery cells or cells that were unused for a longer period (more than 3 months). Ni-MH and Ni-Cd battery cells are affected to capacity degradation (sometimes called as memory effect). As a result the instrument operation time can be significantly reduced.

Recommended procedure for recovering battery cells:

Procedure	Notes
➤ Completely charge the battery.	<i>At least 14h with in-built charger.</i>
➤ Completely discharge the battery.	<i>Can be performed with normal work with the instrument.</i>
➤ Repeat the charge / discharge cycle for at least two times .	<i>Four cycles are recommended.</i>

Complete discharge / charge cycle is performed automatically for each cell using external intelligent battery charger.

Notes:

- ❑ The charger in the instrument is a pack cell charger. This means that the battery cells are connected in series during the charging. The battery cells have to be equivalent (same charge condition, same type and age).
- ❑ One different battery cell can cause an improper charging and incorrect discharging during normal usage of the entire battery pack (it results in heating of the battery pack, significantly decreased operation time, reversed polarity of defective cell...).
- ❑ If no improvement is achieved after several charge / discharge cycles, then each battery cell should be checked (by comparing battery voltages, testing them in a cell charger, etc). It is very likely that only some of the battery cells are deteriorated.
- ❑ The effects described above should not be mixed with normal decrease of battery capacity over time. Battery also loses some capacity when it is repeatedly charged / discharged. The actual decrease of capacity versus number of charging cycles depends on battery type and is provided in the technical specification from battery manufacturer.

2.3 Standards applied

The MI 3101 EurotestAT instrument is manufactured and tested according to the following regulations, listed below.

Electromagnetic compatibility (EMC)

EN 61326	Electrical equipment for measurement, control and laboratory use – EMC requirements Class B (Hand held equipment used in controlled EM environments)
----------	---

Safety (LVD)

EN 61010 - 1	Safety requirements for electrical equipment for measurement, control, and laboratory use – Part 1: General requirements
EN 61010 - 031	Safety requirements for hand-held probe assemblies for electrical measurement and test

Functionality

EN 61557	Electrical safety in low voltage distribution systems up to 1000 V a.c. and 1500 V d.c. - Equipment for testing, measuring or monitoring of protective measures
	Part 1 General requirements
	Part 2 Insulation resistance
	Part 3 Loop resistance
	Part 4 Resistance of earth connection and equipotential bonding
	Part 5 Resistance to earth
	Part 6 Residual current devices (RCDs) in TT and TN systems
	Part 7 Phase sequence
	Part 10 Combined measuring equipment

Other reference standards for testing RCDs

EN 61008	Residual current operated circuit-breakers without integral overcurrent protection for household and similar uses
EN 61009	Residual current operated circuit-breakers with integral overcurrent protection for household and similar uses
EN 60755	General requirements for residual current operated protective devices
EN 60364-4-41	Low-voltage electrical installations - Part 4-41: Protection for safety - Protection against electric shock
EN 60364-5-52	Low-voltage electrical installations - Part 5-52: Selection and erection of electrical equipment - Wiring systems
IEC 62423	Type F and type B residual current operated circuit-breakers with and without integral overcurrent protection for household and similar use
BS 7671	IEE Wiring Regulations
AS / NZ 3760	In-service safety inspection and testing of electrical equipment

Note about EN and IEC standards:

Text of this manual contains references to European standards. All standards of EN 6xxxx (e.g. EN 61010) series are equivalent to IEC standards with the same number (e.g. IEC 61010) and differ only in amended parts required by European harmonization procedure.

3 Instrument description

3.1 Front panel

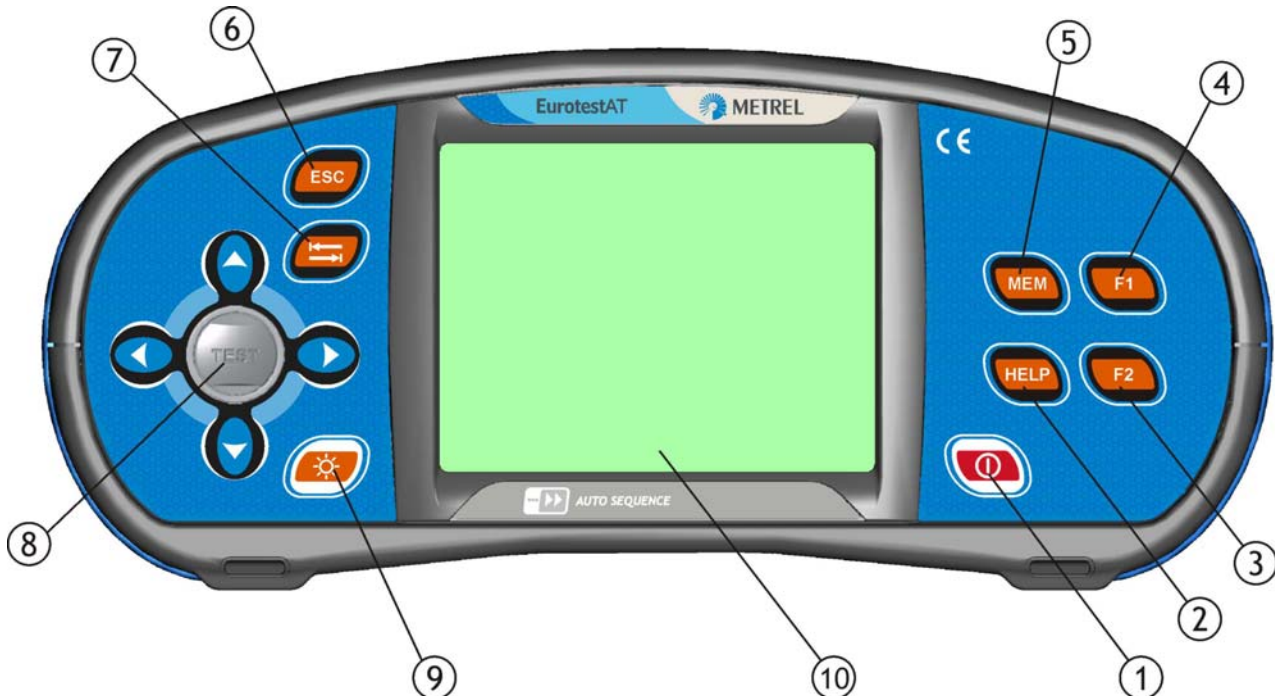

Figure 3.1: Front panel

Legend:

1	ON / OFF	Switches the instrument power on or off. <i>The instrument automatically turns off 15 minutes after the last key was pressed.</i>
2	HELP	Accesses help menus.
3	F2	Adds new memory location. Confirmation of name entered in edit mode.
4	F1	Enters memory editing mode. Deletes character on the left in edit mode.
5	MEM	Handling with memory.
6	ESC	Exits selected and displayed option.
7	TAB	Jumps between display windows.
8	Cursor keypad with TEST key	Cursors Selection of tested function and its working parameters. TEST Initiates measurements. Acts also as the PE touching electrode.
9	BACKLIGHT, CONTRAST	Changes backlight level and contrast.
10	LCD	320 x 240 dots matrix display with backlight.

3.2 Connector panel

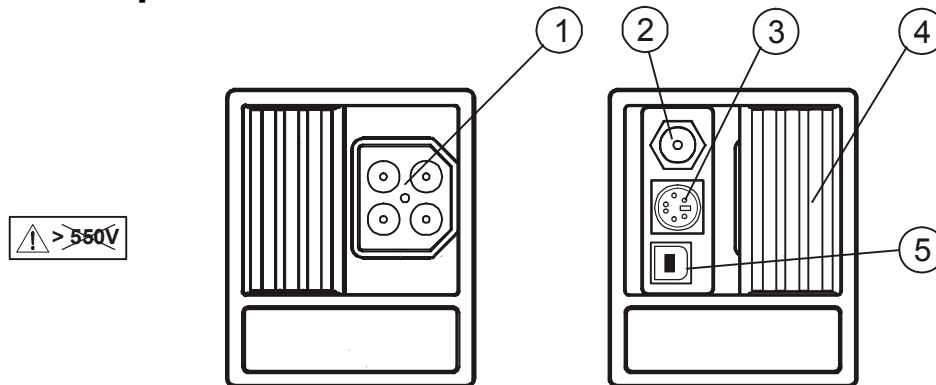

Figure 3.2: Connector panel

Legend:

1	Test connector	Measuring inputs / outputs, connection of measuring cables.
2	Charger socket	Connection of power supply adapter.
3	PS/2 connector	Communication with PC serial port and connection to optional measuring adapters.
4	Protection cover	Protects from simultaneous access to test connector and power supply adapter socket plus communication connectors.
5	USB connector	Communication with PC USB (1.1) port.

Warnings!

- ❑ **Maximum allowed voltage between any test terminal and ground is 600 V!**
- ❑ **Maximum allowed voltage between test terminals is 550 V!**
- ❑ **Maximum short-term voltage of external power supply adapter is 14 V!**

3.3 Back panel

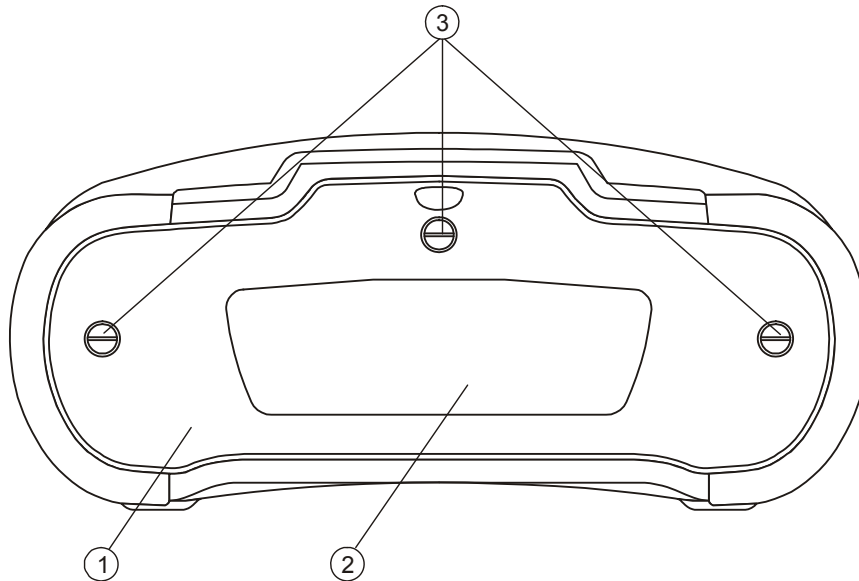

Figure 3.3: Back panel

Legend:

1	Battery / fuse compartment cover
2	Back panel information label
3	Fixing screws for battery / fuse compartment cover

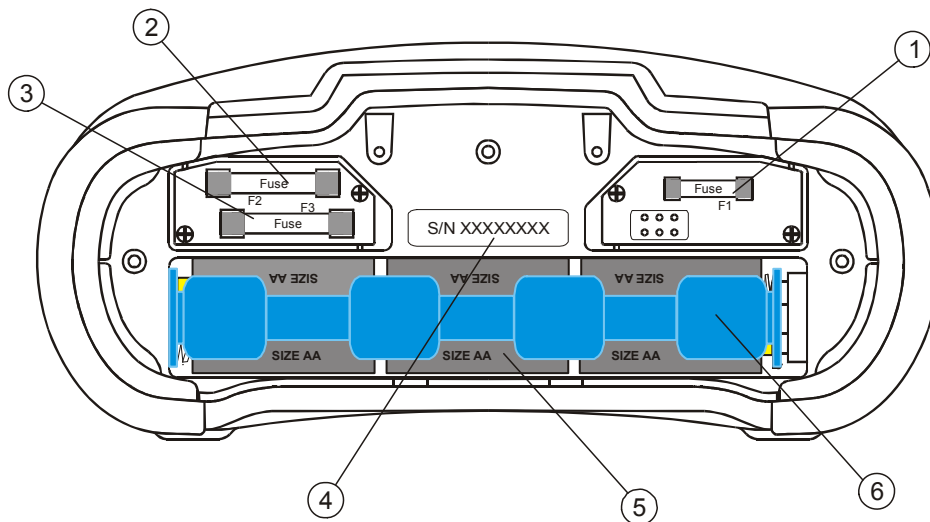

Figure 3.4: Battery and fuse compartment

Legend:

1	Fuse F1	T 315 mA / 250 V
2	Fuse F2	T 4 A / 500 V
3	Fuse F3	T 4 A / 500 V
4	Serial number label	
5	Battery cells	Size AA, alkaline / rechargeable NiMH or NiCd
6	Battery holder	Can be removed from the instrument

3.4 Bottom

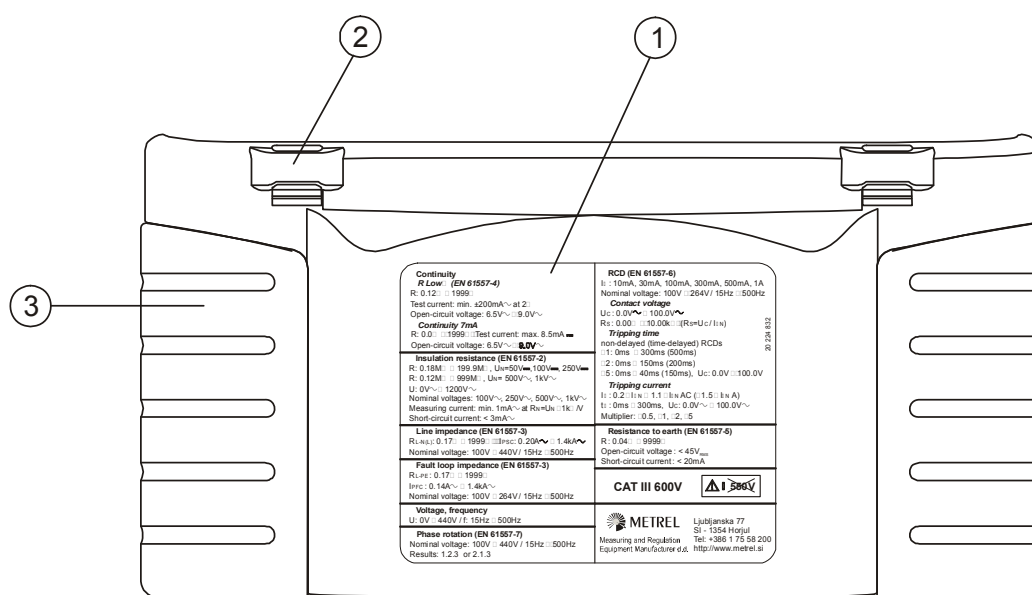

Figure 3.5: Bottom

Legend:

- 1 Bottom information label
- 2 Neck belt openings
- 3 Handling side covers

3.5 Display organization

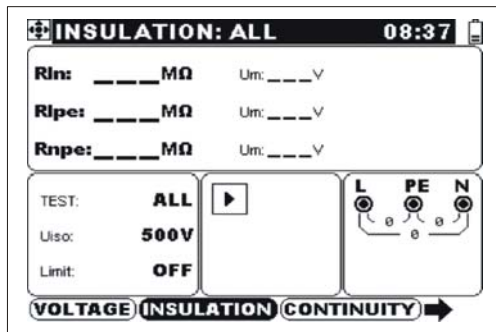

Figure 3.6: Typical single test display

INSULATION: ALL 08:37	Menu line
Rln: ___ MΩ Um: ___ V Rlpe: ___ MΩ Um: ___ V Rnpe: ___ MΩ Um: ___ V	Result field
TEST: ALL Uiso: 500V Limit: OFF	Test parameter field
[Play icon]	Message field
L PE N terminal diagram	Terminal voltage monitor
VOLTAGE INSULATION CONTINUITY [Arrow]	Function tabs

3.5.1 Terminal voltage monitor

The terminal voltage monitor displays current voltages present on the test terminals. In its lower part messages are displayed regarding the measured voltages and selected voltage system (see 4.4.2 Supply system).

	Online voltage is displayed together with test terminal indication.
	L and N test terminals are used for selected measurement.
	L and PE are test terminals; N terminal should also be connected for reference in measuring circuit.
	Polarity of test voltage applied to the output terminals.
	Insulation test: two measuring terminals should be shorted.
123, 321	Three-phase connection indicator.
TT TN	TT / TN supply system.
IT	IT supply system.
RV	Reduced low voltage supply system.
?	Unknown supply system (atypical voltage at input terminals for selected supply system).
	L – N polarity changed.
SF	First fault in IT supply system. Check monitored voltages to fix the problem.



Warning! Phase voltage on the PE terminal! Stop the activity immediately and eliminate the fault / connection problem before proceeding with any activity!

3.5.2 Menu line

In the menu line the name of the selected function is displayed. Additional informations about active cursor / TEST keys and battery condition are shown.

INSULATION: ALL	Function name.
08:37	Time.
	Active keys on cursor / TEST keypad (↓ and TEST in this example).
	Battery capacity indication.
	Low battery. Battery is too weak to guarantee correct result. Replace or recharge the battery cells.
	Recharging in progress (if power supply adapter is connected).

3.5.3 Message field

In the message field different warnings and messages are displayed.

	Warning! High voltage is applied to the test terminals.
	Measurement is running, consider displayed warnings.
	Conditions on the input terminals allow starting the measurement (TEST key), consider other displayed warnings and messages.
	Conditions on the input terminals do not allow starting the measurement (TEST key), consider displayed warnings and messages.
	Test leads resistance in CONTINUITY tests is not compensated, see Chapter 5.2.3 for compensation procedure.
	Test leads resistance in CONTINUITY tests is compensated.
	Indicator for optional Z max subfunction in Z-LOOP function.
	Possibility to perform reference measurement (Zref) in ■ sub-function.
	RCD tripped-out during the measurement (in RCD functions).
	Instrument is overheated, the temperature inside the instrument is higher than the safety limit, and measurement is prohibited until the temperature decreases under the allowed limit.
	Fuse F1 has blown or not inserted (CONTINUITY and EARTH functions).
	It is possible to store result(s).



High electrical noise during measurement. Results may be impaired.



Probe resistances Rc or Rp could influence earth resistance result.



Pause activated in auto sequence test. Follow required activity for paused test function.

3.5.4 Result field – tests



Measurement result is inside pre-set limits (PASS).



Measurement result is out of pre-set limits (FAIL).



Measurement is aborted. Consider displayed warnings and messages.

3.5.5 Result field – inspections



Inspection PASSED.



Inspection FAILED.



Inspection was not applicable.



Inspection was performed in LIMITED extent.



Inspection was not performed.

3.5.6 Other messages

Hard Reset

Instrument settings and measurement parameters/limits are set to initial (factory) values, for more information refer to chapter 4.8.5. *Recalling original settings.*

CAL ERROR!

Service intervention required.

3.5.7 Sound warnings

Periodic sound

Warning! Dangerous voltage on the PE terminal is detected. Refer to chapter 5.8 for more information.

3.5.8 Help

Key:

HELP	Opens help screen.
-------------	--------------------

The help menus contains some basic schematic / connection diagrams to illustrate recommended connection of the instrument to the electrical installation and information about the instrument.

Pressing the **HELP** key in single test generates help screen for selected single test function, while in other working menus the voltage system help is displayed first.

Keys in help menu:

← / →	Select neighbour help screen.
HELP	Rotates through help screens.
ESC	Exits help menu.

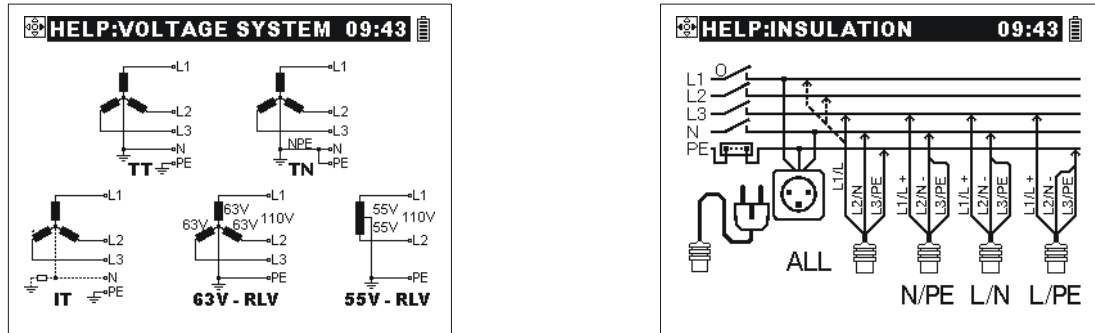

Figure 3.7: Examples of help screen

3.5.9 Backlight and contrast adjustments

With the **BACKLIGHT** key backlight and contrast can be adjusted.

Click Toggle backlight intensity level.

Keep pressed for **1 s** Lock high intensity backlight level until power is turned off or the key is pressed again.

Keep pressed for **2 s** Bargraph for LCD contrast adjustment is displayed.

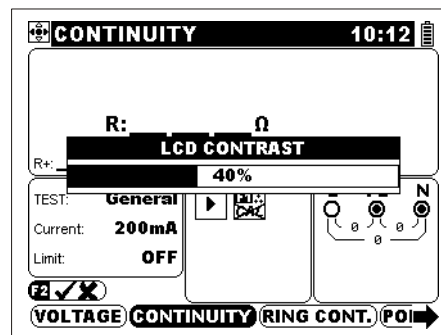

Figure 3.8: Contrast adjustment menu

Keys for contrast adjustment:

←	Reduces contrast.
→	Increases contrast.
TEST	Accepts new contrast.
ESC	Exits without changes.

3.6 Carrying the instrument

With the neck-carrying belt supplied in standard set, various possibilities of carrying the instrument are available. Operator can choose appropriate one on basis of his operation, see the following examples:

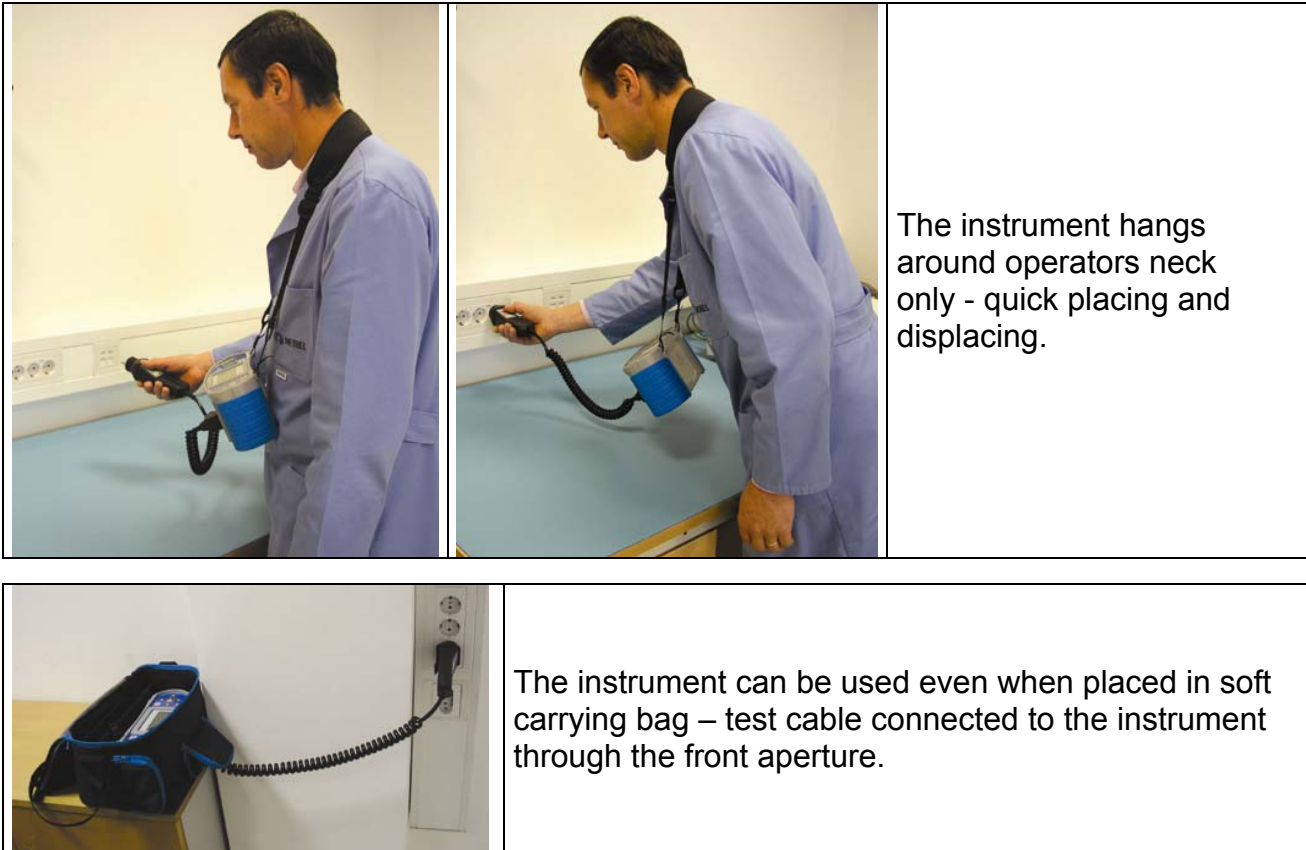

3.7 Instrument set and accessories

3.7.1 Standard set

- ❑ Instrument
- ❑ Soft carrying bag
- ❑ Short instruction manual
- ❑ Product verification data
- ❑ Warranty declaration
- ❑ Declaration of conformity
- ❑ Universal test cable
- ❑ Three test tips
- ❑ Plug cable
- ❑ Three alligator clips
- ❑ Power supply adapter
- ❑ CD with instruction manual, handbook *Measurements on electric installations in theory and practice*, PC software
- ❑ USB interface cable
- ❑ RS232 interface cable

3.7.2 Optional accessories

See the attached sheet for a list of optional accessories that are available on request from your distributor.

4 Instrument operation

4.1 Main menu

From the **Main** menu different instrument operation modes can be set.

- ❑ Single test / inspection menu (see 4.2),
- ❑ Auto sequence menu (see 4.3),
- ❑ Miscellaneous (see 4.4).

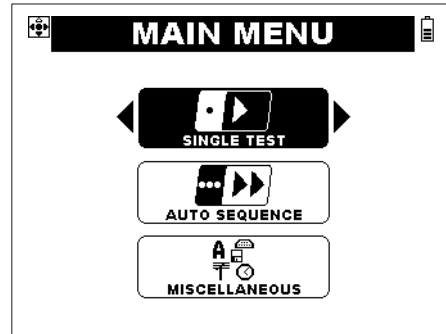



Figure 4.1: Main menu

Keys:

← / →	Toggle between Single test and Inspection menu
↓ / ↑	Select the mode.
TEST	Enters selected mode.

4.2 Single test / Inspection

 is intended to run individual measurement functions.

 is intended for visual inspections.

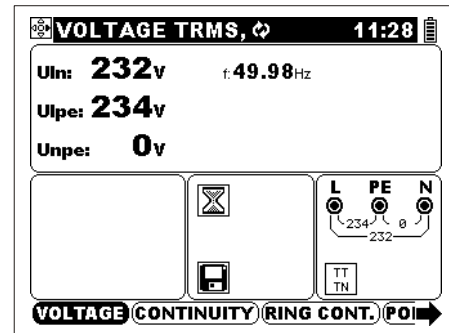

Figure 4.2: Example of typical Single test screen

Keys in main **Single test** screen:

← / →	Select test / measurement function: <ul style="list-style-type: none"> <input type="checkbox"/> <VOLTAGE> Voltage and frequency plus phase sequence. <input type="checkbox"/> <CONTINUITY> Resistance to earth connection and equipotential bonding. <input type="checkbox"/> <RING CONT.> Resistance of conductors in ring final circuits. <input type="checkbox"/> <POLARITY> Test for verification of wiring. <input type="checkbox"/> <INSULATION> Insulation resistance. <input type="checkbox"/> <Z-LINE> Line impedance. <input type="checkbox"/> <Z-LOOP> Fault loop impedance. <input type="checkbox"/> <RCD> RCD testing. <input type="checkbox"/> <EARTH> Resistance to earth. <input type="checkbox"/> <VARISTOR TEST> Transient suppressor test.
↓ / ↑	Select sub-function in selected measurement function.
TEST	Runs selected test / measurement function.
TAB	Enters test parameters field.
ESC	Exits single test operation mode.
MEM	Stores measured results / recalls stored results.

Keys in **test parameter** field:

↓ / ↑	Select measuring parameter.
← / →	Change the selected parameter.
TEST, TAB, ESC	Exit back to main single test screen.

General rule for enabling **limits** for evaluation of measurement / test result:

Limit	OFF	No limit comparison
	ON	Limit ON – enabled comparison Limit Value – minimum / maximum limit value *

* Type of limit value depends on particular function.

Keys in main **Inspection** screen:

← / →	Select inspection type: <input type="checkbox"/> <FULL SCHEDULE> Schedule for standard installations. <input type="checkbox"/> <DOMESTIC SCHEDULE > Schedule for domestic installations. <input type="checkbox"/> <FUNCTIONAL INSPECTION> Schedule for functional inspection at the end of tests.
TEST	Starts selected inspection / selection.
F2	Clears all schedule flags.
ESC	Stops inspection.
MEM	Stores inspection results / recalls inspection results.

See *Chapter 5* for more information about operation of the instrument in single test and inspection functions.

4.3 Automatic testing



is intended for automatic executing of predefined measurement sequences.

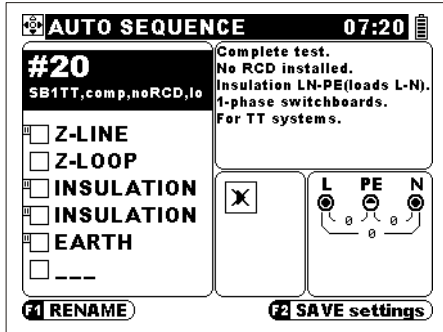

Figure 4.3: Typical auto sequence screen

AUTO SEQUENCE	Auto sequence menu.
#20 SB1TT,comp,noRCD,lo	Selected sequence number and (optional) name.
<input type="checkbox"/> Z-LINE <input type="checkbox"/> Z-LOOP <input type="checkbox"/> INSULATION <input type="checkbox"/> INSULATION <input type="checkbox"/> EARTH <input type="checkbox"/> ----	Sequence field.
Complete test. No RCD installed. Insulation LN-PE(loads L-N). 1-phase switchboards. For TT systems.	Test parameter / auto sequence description field.
F1 RENAME F2 SAVE settings	Saving and renaming options.

Running auto sequence:

- ❑ Select auto sequence (see 4.3.2).
- ❑ Connect the instrument to tested object as required for the first measurement in the sequence.
- ❑ Press TEST key.
- ❑ The sequence will pause at the functions marked with pause flag [||]. Comments regarding the paused function will be displayed (optional).
 - ◆ Press the TAB key to toggle between comments menu and auto sequence main menu.
 - ◆ If the conditions at input terminals are valid, the test will proceed after pressing the TEST key.
 - ◆ Press the F1 key to skip the paused function. The test will continue with the next test (if any) or will end.
 - ◆ Press the ESC key to skip the remaining functions and finish the auto sequence.
- ❑ The set of measurements will be performed in sequential manner until the conditions at input terminals are valid for each individual test. If not, the instrument will stop (the buzzer sounds). The auto sequence will proceed:
 - ◆ After correct conditions are restored at the input terminal (e.g. by reconnecting, switching on the RCD).
 - ◆ If pressing the F1 key this function will be skipped.
 - ◆ By pressing the ESC key to skip the remaining functions and finish the auto sequence.
- ❑ Results of a finished auto sequence can be viewed and stored. See chapter 6. for more information.

Measurements are marked with one of the following symbol after finished test.

<input checked="" type="checkbox"/>	CONTINUITY	Measurement is finished and has failed.
<input checked="" type="checkbox"/>	INSULATION	Measurement is finished and has passed.
<input type="checkbox"/>	VOLTAGE	Measurement is finished. No comparison limit was applied.
<input type="checkbox"/>	Z-LINE	Measurement is not performed yet (during test) or was skipped.
✓		Overall PASS result is reported if all performed tests passed.
✗		Overall FAIL result is reported if one or more performed tests failed.

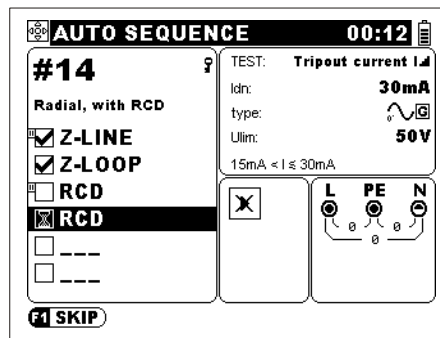

Figure 4.4: Waiting for right input condition to proceed

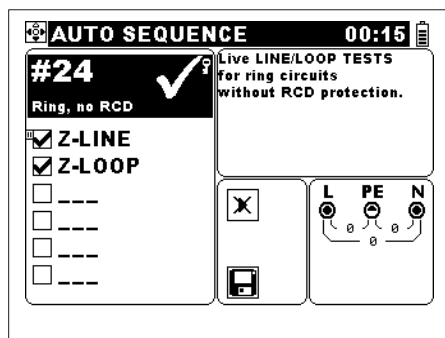

Figure 4.5: Overall PASS example

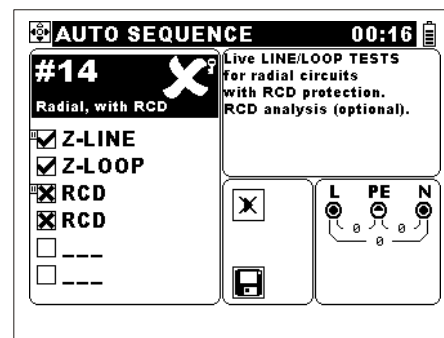

Figure 4.6: Overall FAIL example

4.3.1 Auto sequence number main menu

In the instrument up to 99 automatic sequences can be stored.

#3	Auto sequence number.
*	Indicator that the preset sequence was changed and is not stored yet, the auto sequence can be performed anyway.
#3* TEST EXA1	Optional sequence name (see 4.3.4).
f	Indication of locked sequence (see 4.3.2).

Viewing auto sequence particular results:

- After finished auto sequence press the key ↓ to move focus into sequence field.
 - ◆ Press TEST key.
 - ◆ Result of selected function is displayed.
 - ◆ Press TEST or ESC key to exit from current view.
 - ◆ Press the key ↓ (or ↑) to select the next function of the sequence.

- ◆ Repeat this part until all results are observed.
- Viewing of the results is finished by pressing the key **↑** until selected sequence number is focused or by pressing the ESC key.

4.3.2 Auto sequence set

Keys in main auto sequence menu:

TEST	Starts the selected test sequence. Enters / clears pause before test.
← / →	Select the test sequence number or measuring function (see 4.3.1).
↓ / ↑	Select individual sequence step / measuring function.
TAB	Enters test parameter field (see 4.3.3).
ESC	Exits auto sequence menu without changes.
F1	Enters editor to rename selected test sequence and enter its description (see 4.3.4). Enters menu for setting pause flag and comments (see 4.3.7).
F2	Saves entered test sequence (see 4.3.5).
MEM	Stores / recalls AUTO SEQUENCE results.

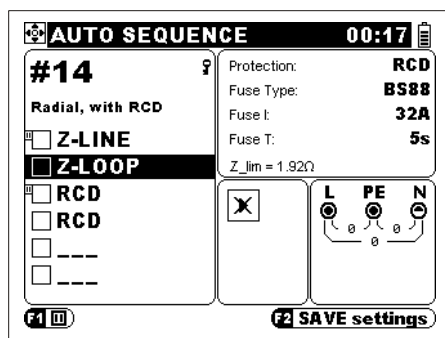

Function selection

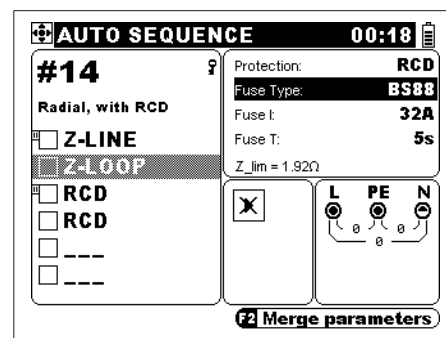

Parameter selection

Figure 4.7: Example of setting auto sequence

For each of 6 predefined sequence steps any of the following measurement function can be selected: voltage, continuity, insulation, Zline, Zloop, RCD and earth. The field can also be left empty (- - -).

Test parameters are applied to individual measurements as in the single test. The test parameter menu of selected measurement is available on the right side of the display.

The **pause** **||** flag holds the auto sequence until prosecution is confirmed with the **TEST** key. It is recommended to use it if additional checks or reconnections have to be performed before performing the next measurement.

The key is indication of locked sequence. This indication appears at predefined sequences that were loaded into the instrument from PC. It is possible to modify locked auto sequences and run them. However, the modified sequence cannot be stored by overwriting.

Note:

- It is recommended to save current auto sequence if modified or new prepared, to keep it during manipulation.

4.3.3 Test parameters in auto sequence

Keys in test parameter menu (in auto sequence):

← / →	Select test parameter value or enable / disable parameter.
↓ / ↑	Select test parameter.
TEST, TAB, ESC	Return to auto sequence main screen.

Whenever a new function is selected for auto sequence its test parameters should be verified and changed to appropriate values / states.

Test parameter merging

When the prepared sequence from *section 4.3.2* contains selected at least two of Zline, Zloop, or RCD, is possible to merge test parameters of one function to others of mentioned in the same sequence.

Merged parameters are related to:

- fuse data, and
- RCD data, except start polarity of test current.

Additional Key in main auto sequence menu with selected Zline, Zloop, or RCD:

F2	Merges test parameters.
-----------	-------------------------

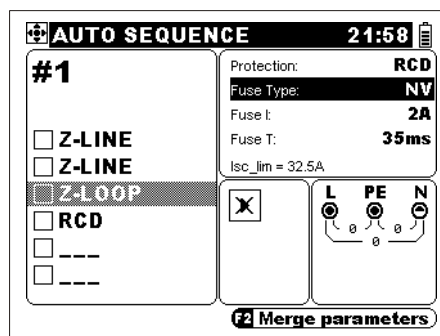

Figure 4.8: Parameter merging possibility

4.3.4 Name and description of auto sequence

F1	Enters test sequence name menu from auto sequence main menu.
-----------	--

Name and description for the selected auto sequence can be added or changed (optional) in this two level menu.

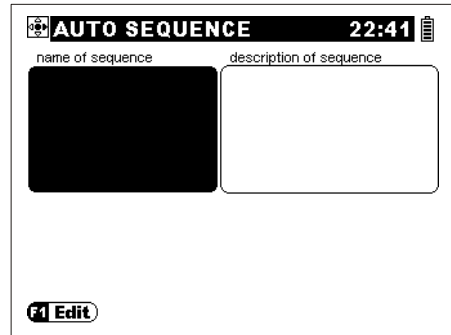

Figure 4.9: Auto sequence name menu

Keys for 1st level:

← / →	Select between name and description field.
TEST	Returns to auto sequence main menu.
F1	Enters editing of selected field (2 nd level).
ESC	Returns to auto sequence main menu without changes.

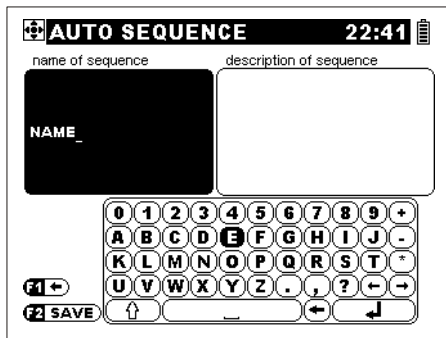

Figure 4.10: Auto sequence name edit menu

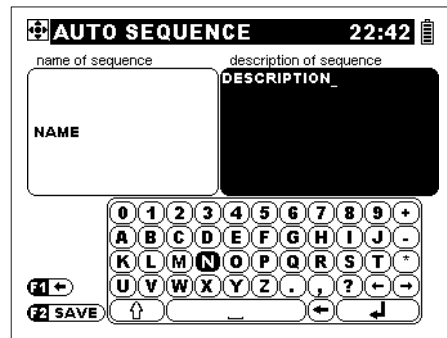

Figure 4.11: Auto sequence description edit menu

Keys for 2nd level:

Highlighted key	Selected symbol or activity.
← / → / ↓ / ↑	Select symbol or activity.
TEST	Enters selected symbol or performs selected activity.
F1	Deletes last entered symbol in the name line.
F2	Confirms name and returns to 1 st level of auto sequence name menu.
ESC	Returns to 1 st level of auto sequence name menu without changes.

20 characters is the maximum length of the auto sequence name.

100 characters is the maximum length of the auto sequence description.

4.3.5 Storing auto sequence settings (sequence, number, name)

F2	Opens dialog for storing auto sequence settings in auto sequence main menu.
-----------	---

The dialog enables storing existing auto sequence settings into different location or overwriting existing.

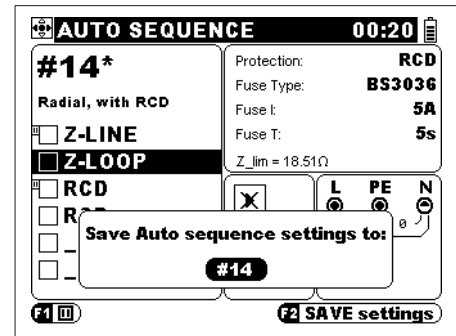

Figure 4.12: Store dialog

Keys:

← / →	Select the auto sequence number.
TEST	Confirms the storing.
ESC	Returns to auto sequence main menu without changes.

Auto sequence settings are stored in nonvolatile memory. Stored auto sequence procedures remain in memory until the user changes them.

It is not possible to store any auto sequence in locked location. Locked auto sequence can be copied in an unlocked location. Stored sequence is unlocked in this case.

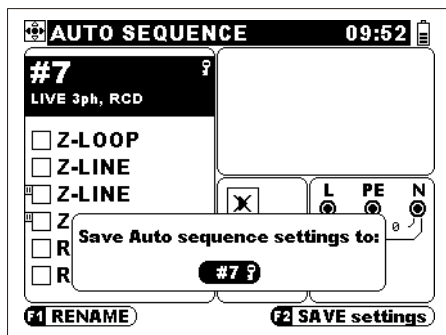

Figure 4.13: Store dialog for locked sequence

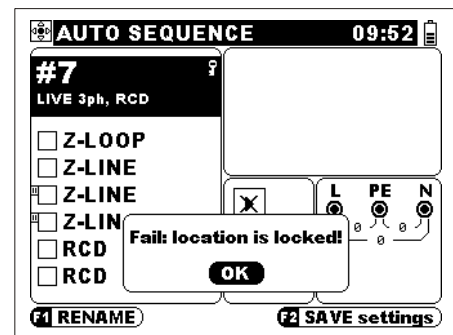
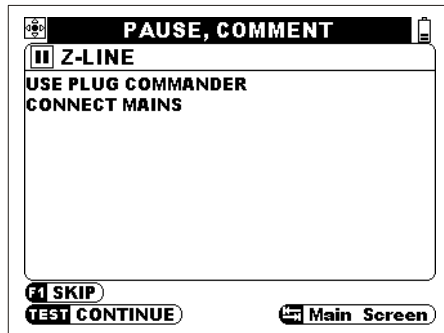

Figure 4.14: Failed storing

It is possible to unlock all locked sequences (see 4.4.5 for more information) if necessary.

4.3.6 Pause flag and comments in auto sequence

The auto sequence holds if a pause flag is associated with the measurement and the pre-defined comment is displayed. When the input conditions are regular, the auto sequence can be continued by pressing the **TEST** key.



Comment appears with the pause

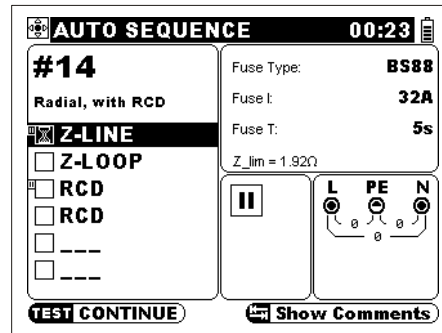

Blinking pause flag in main screen

Figure 4.15: Examples of screens during the pause in auto sequence

Keys:

TAB	Toggles between comment screen and auto sequence main screen.
TEST	Continues with the paused test.
F1	Skip paused test.
ESC	Skip all tests and ends auto sequence.

4.3.7 Setting pause flag and comments

Operator of the instrument can prepare comments regarding the measurements. Warnings, reconnection hints or other useful remarks related to the test sequence can be applied this way.

F1	Enters pause set-up and comments menu for selected function in auto sequence main menu.
-----------	---

Set-up of comments is enabled if pause flag is set to ON.

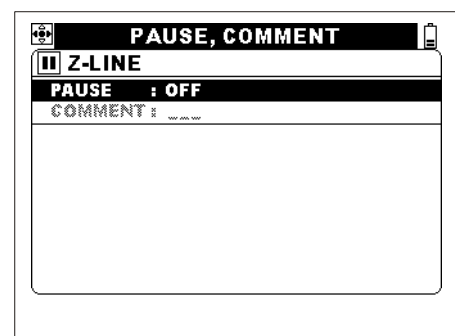

Figure 4.16: Pause set-up menu

Keys:

← / →	Enable (ON) / disable (OFF) pause flag.
↓ / ↑	Select between pause flag and comments fields.
TEST	Confirms pause and comment selection, and returns to auto sequence main menu.
ESC	Returns to auto sequence main menu without changes.

Comments set-up menu enables selection and editing of the pause comment.

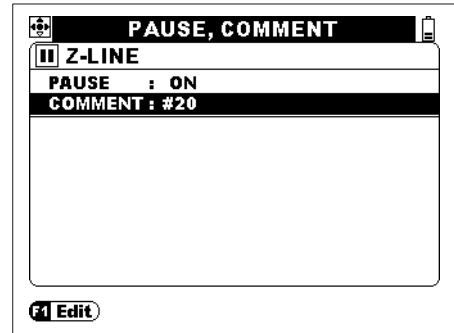

Figure 4.17: Comments set-up menu

Keys:

↓ / ↑	Select between setup of pause and comment.
← / →	Select comment [--- (no comment), #1 ÷ #99].
F1	Enters edit comments menu for selected comment number.
TEST	Confirms pause and comment selection and returns to auto sequence main menu.
ESC	Returns to auto sequence main menu without changes.

Comments can be entered and edited in the Edit comments menu.

Maximum comment length: 250 characters (including space and new line characters).

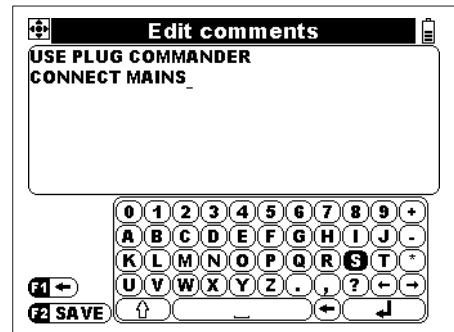

Figure 4.18: Comments edit menu

Keys:

Highlighted key	Selected symbol or activity.
← / → / ↓ / ↑	Select symbol or activity.
TEST	Enters selected symbol or performs selected activity.
F1	Deletes last entered symbol.
F2	Opens dialog for comment storing.
ESC	Deletes comment (immediately after entering the editor). Returns to auto sequence main menu without changes.

Storing comment opens dialog for storing into selected location.

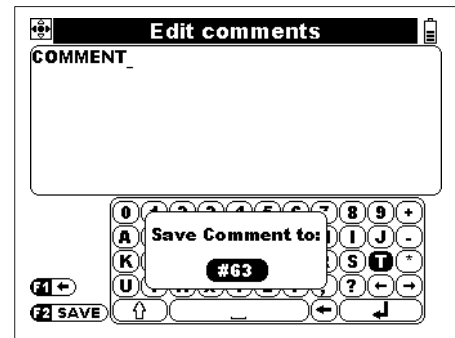

Figure 4.19: Store dialog for comment

Keys:

← / →	Select comment number.
TEST	Confirms storing the comment and returns.
ESC	Returns to Edit comments menu.

Note:

- It is not possible to overwrite comments associated to locked auto sequences.

4.3.8 Building an auto sequence

The instrument supports up to 99 auto sequences, each consisting of up to 6 steps. It is not necessary that all steps are enabled.

The auto sequence can be prepared in the following way:

- By storing the existing auto sequence under another auto sequence number (see 4.3.5),
- By changing an existing auto sequence and saving it under the same auto sequence number (not possible for locked auto sequence),
- By building a new auto sequence.

Building a new auto sequence

- In the main menu (see 4.1) select **auto sequence**.
- Press the **TEST** key.
- Select **auto sequence number** (see 4.3.2).
- Repeat until finished (maximum 6 steps):
 - ◆ Select **auto sequence step** (see 4.3.2).
 - ◆ Select auto sequence **function** (see 4.3.2).
 - ◆ Select auto sequence **test parameters** of the function (see 4.3.3).
 - ◆ Set / reset pause flag  and select or create new comment if necessary (see 4.3.7).
- Name (or **rename**) the auto sequence and enter its description (see 4.3.4).
- Save prepared auto sequence (see 4.3.5).

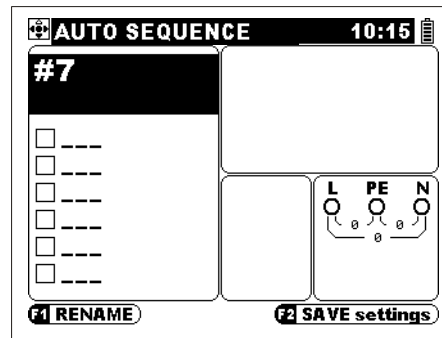

Figure 4.20: Blank auto sequence

Example of building an auto sequence

A radial circuit (fuse type BS88, $I_n = 6 \text{ A}$, $t_d = 5 \text{ s}$) with RCD (type AC, $I_{\Delta N} = 30 \text{ mA}$) shall be tested.

The following measurements must be performed:

- Line (phase-neutral) / Loop (phase-PE) impedances and prospective short circuit /prospective fault currents,
- Complete RCD analysis,
- RCD trip-out time at increased current ($5 \times I_{\Delta N}$).



The name of test sequence number 10 is “Radial, with RCD”. Description of the test sequence is: “Live LINE/LOOP TESTS for radial circuits with RCD protection. RCD analysis (optional).”.

For the measurement the following conditions shall apply:

- Tests have to be applied on energized test socket with the plug cable or the universal test cable (see figures 5.30, 5.39 and 5.43).

Example:

Item/keys	Chapter reference	Comment
Auto sequence, TEST	4.1	Selection of auto sequence operation in main menu.
← / →	4.3.1	Selection of test sequence number 10 .
F1	4.3.4	Enter into sequence name editing menu.
F1	4.3.4	Enter the sequence name editor.
Radial, with RCD	4.3.4	Enter the name of auto sequence.
F2	4.3.4	Accept name and exit into sequence name editing menu.
→	4.3.4	Select description of test field.
F1	4.3.4	Enter the description of test editor.
Live LINE/LOOP TESTS for radial circuits with RCD protection. RCD analysis (optional).	4.3.4	Enter the description.
F2	4.3.4	Accept description and exit into sequence description editing menu.
TEST	4.3.4	Exit sequence name editing menu.
↓	4.3	Enter into sequence field.
← / →	4.3.2	Select Z-LINE .

TAB	4.3.2	Enter test parameter selection mode.
FUSE type BS88 FUSE I 6A FUSE T 5s	5.5	Set test parameters for line impedance.
TAB	4.3.2	Exit parameter mode.
F1	4.3.2	Set PAUSE (wait to prepare for measurement).
← / →	4.3.7	Set PAUSE: ON .
↓	4.3.7	Select COMMENT .
← / →	4.3.7	Select COMMENT: #1 .
F1	4.3.7	Enter Edit comment menu.
Insert plug into socket	4.3.7	Enter the comment.
F2	4.3.7	Save the comment.
TEST	4.3.7	Store the comment to location #1 .
TEST	4.3.7	Confirm selected pause and its comment.
↓	4.3	Next step.
← / →	4.3.2	Select Z-LOOP
TAB	4.3.2	Enter test parameter selection mode.
Protection: RCD FUSE type BS88 FUSE I 6A FUSE T 5s	5.1	Setting test parameters for loop impedance.
TAB	4.3.2	Exit parameter mode.
↓	4.3	Next step.
← / →	4.3.2	Select RCD .
TAB	4.3.2	Enter parameter mode.
TEST AUTO Idn 30mA type  Ulim 50V	5.3	Setting test parameters for RCD – Auto test.
TAB	4.3.2	Exit parameter mode.
F1	4.3.2	Set PAUSE (wait to activate RCD).
← / →	4.3.7	Set PAUSE: ON .
↓	4.3.7	Select COMMENT .
← / →	4.3.7	Select COMMENT: #2 .
F1	4.3.7	Enter Edit comment menu.
RCD functionality test. Rearm RCD each time it trips out.	4.3.7	Enter the comment.
F2	4.3.7	Save the comment.
TEST	4.3.7	Store the comment to location #2 .
TEST	4.3.7	Confirm selected pause and its comment.
↓	4.3	Next step.
← / →	4.3.2	Select RCD .
TAB	4.3.2	Enter test parameter selection mode.
TEST Tripout current Idn 30mA type  Ulim 50V	5.3	Setting test parameters for RCD tripout current test.
TAB	4.3.2	Exit parameter mode.
↑ (4 x)	4.3	Exit the editing of sequence field.

F2	4.3.5	Store prepared test sequence.
TEST	4.3.5	Confirm storing.

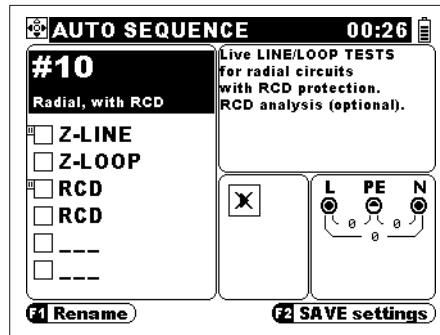



Figure 4.21: Auto sequence screen of the example above

4.4 Miscellaneous

Different instrument options can be set in the  menu.

Options are:

- ❑ Selection of language,
- ❑ Selection of mains supply system,
- ❑ Recalling and clearing stored results,
- ❑ Setting date and time,
- ❑ Selection of communication port,
- ❑ Setting the instrument to initial values,
- ❑ Entering locator function,
- ❑ Selection of operator.

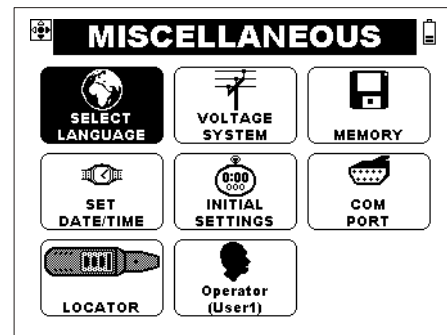

Figure 4.22: Options in Miscellaneous menu

Keys:

↓ / ↑ / ← / →	Selection of option.
TEST	Enters selected option.
ESC	Returns to the main menu.

4.4.1 Language

The instrument supports different languages.

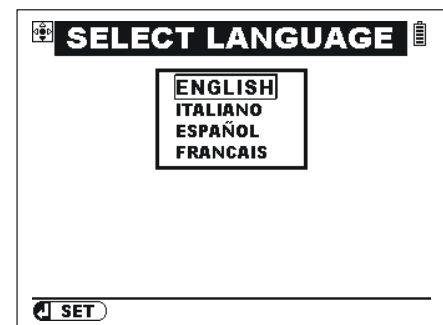

Figure 4.23: Language selection

Keys:

↓ / ↑	Select language.
TEST	Confirms selected language and exits to settings menu.
ESC	Exits to settings menu without changes.

4.4.2 Supply system, Isc factor, RCD standard

In the **Voltage system** menu the following parameters can be selected:

Voltage system	Mains supply system type.
Set Isc factor	Correction factor for limit of maximum line/loop impedance.
RDC testing	RCD normative reference.

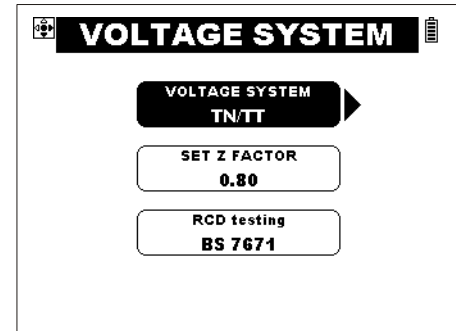

Figure 4.24: System parameters

Keys:

↓ / ↑	Select option.
← / →	Change the option.
TEST	Confirms selected option.
ESC	Exits to settings menu with new setup.

Mains supply systems

The following supplying systems are supported:

- TN / TT (earthed systems),
- IT (system insulated from earth),
- 110 V reduced low voltage (2 x 55 V center tap grounded),
- 110 V reduced low voltage (3 x 63 V three phase, star center grounded).

TN, TT and IT systems are defined in EN 60364-1 standard. 110 V reduced low voltage systems are defined in BS 7671.

See *Appendix D* for particular characteristics of IT supply system measurements and instrument characteristics.

See *Appendix E* for particular characteristics of 110 V reduced low voltage supply systems measurements and instrument characteristics.

Z factor - ksc

Maximum impedance in the supply system is important for selection or verification of protective circuit breakers (fuses, over-current breaking devices, RCDs).

The default value of ksc is 0.75. Select the value as required by local regulative for tested type of mains supply system.

Z factor can be selected of 0.75 and 0.80.

RCD normative references

Maximum RCD disconnection times differ in various standards.
The trip-out times defined in individual standards are listed below.

Trip-out times according to EN 61008 / EN 61009:

	$\frac{1}{2} \times I_{\Delta N}^{*)}$	$I_{\Delta N}$	$2 \times I_{\Delta N}$	$5 \times I_{\Delta N}$
General RCDs (non-delayed)	$t_{\Delta} > 300$ ms	$t_{\Delta} < 300$ ms	$t_{\Delta} < 150$ ms	$t_{\Delta} < 40$ ms
Selective RCDs (time-delayed)	$t_{\Delta} > 500$ ms	$130 \text{ ms} < t_{\Delta} < 500$ ms	$60 \text{ ms} < t_{\Delta} < 200$ ms	$50 \text{ ms} < t_{\Delta} < 150$ ms

Trip-out times according to EN 60364-4-41:

	$\frac{1}{2} \times I_{\Delta N}^{*)}$	$I_{\Delta N}$	$2 \times I_{\Delta N}$	$5 \times I_{\Delta N}$
General RCDs (non-delayed)	$t_{\Delta} > 999$ ms	$t_{\Delta} < 999$ ms	$t_{\Delta} < 150$ ms	$t_{\Delta} < 40$ ms
Selective RCDs (time-delayed)	$t_{\Delta} > 999$ ms	$130 \text{ ms} < t_{\Delta} < 999$ ms	$60 \text{ ms} < t_{\Delta} < 200$ ms	$50 \text{ ms} < t_{\Delta} < 150$ ms

Trip-out times according to BS 7671:

	$\frac{1}{2} \times I_{\Delta N}^{*)}$	$I_{\Delta N}$	$2 \times I_{\Delta N}$	$5 \times I_{\Delta N}$
General RCDs (non-delayed)	$t_{\Delta} > 1999$ ms	$t_{\Delta} < 300$ ms	$t_{\Delta} < 150$ ms	$t_{\Delta} < 40$ ms
Selective RCDs (time-delayed)	$t_{\Delta} > 1999$ ms	$130 \text{ ms} < t_{\Delta} < 500$ ms	$60 \text{ ms} < t_{\Delta} < 200$ ms	$50 \text{ ms} < t_{\Delta} < 150$ ms

Trip-out times according to AS/NZ^{**}):

RCD type	$I_{\Delta N}$ [mA]	$\frac{1}{2} \times I_{\Delta N}^{*)}$ t_{Δ}	$I_{\Delta N}$ t_{Δ}	$2 \times I_{\Delta N}$ t_{Δ}	$5 \times I_{\Delta N}$ t_{Δ}	Note
I	≤ 10	> 999 ms	40 ms	40 ms	40 ms	Maximum break time
II	$> 10 \leq 30$		300 ms	150 ms	40 ms	
III	> 30		300 ms	150 ms	40 ms	
IV 	> 30	> 999 ms	500 ms	200 ms	150 ms	
			130 ms	60 ms	50 ms	

^{*)} Minimum test period for current of $\frac{1}{2} \times I_{\Delta N}$, RCD shall not trip-out.

^{**)} Test current and measurement accuracy correspond to AS/NZ requirements.

Maximum test times related to selected test current for general (non-delayed) RCD

Standard	$\frac{1}{2} \times I_{\Delta N}$	$I_{\Delta N}$	$2 \times I_{\Delta N}$	$5 \times I_{\Delta N}$
EN 61008 / EN 61009	300 ms	300 ms	150 ms	40 ms
EN 60364-4-41	1000 ms	1000 ms	150 ms	40 ms
BS 7671	2000 ms	300 ms	150 ms	40 ms
AS/NZ (I, II, III)	1000 ms	1000 ms	150 ms	40 ms

Maximum test times related to selected test current for selective (time-delayed) RCD

Standard	$\frac{1}{2} \times I_{\Delta N}$	$I_{\Delta N}$	$2 \times I_{\Delta N}$	$5 \times I_{\Delta N}$
EN 61008 / EN 61009	500 ms	500 ms	200 ms	150 ms
EN 60364-4-41	1000 ms	1000 ms	200 ms	150 ms
BS 7671	2000 ms	500 ms	200 ms	150 ms
AS/NZ (IV)	1000 ms	1000 ms	200 ms	150 ms

4.4.3 Memory

In this menu the stored data can be recalled, viewed and cleared. See chapter 6 *Data handling* for more information.

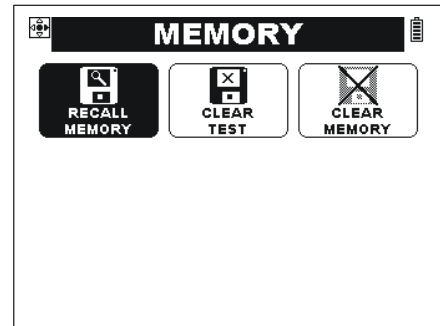

Figure 4.25: Memory options

Keys:

← / →	Select option.
ESC	Exits this option.
TEST	Enters selected option.

4.4.4 Date and time

Date and time can be set in this menu.

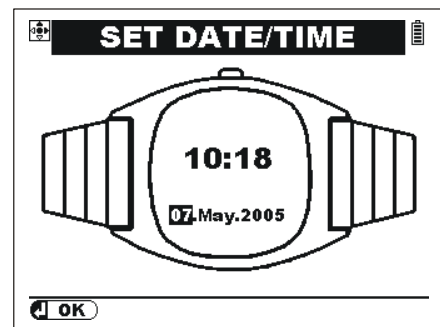

Figure 4.26: Setting date and time

Keys:

→	Selects the field to be changed.
↑ / ↓	Modify selected field.
ESC	Exits date and time setup without changes.
TEST	Confirms new setup and exits.

4.4.5 Initial settings

Instrument settings and measurement parameters and limits are set to their initial values in this menu.

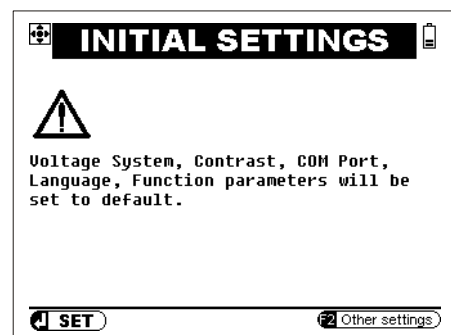

Figure 4.27: Initial settings dialogue

Keys:

TEST	Restores default settings.
ESC	Exits the menu without changes.
F2	Opens other settings menu.

Warning:

- Custom made settings will be lost when this option is used!

The default setup is listed below:

Instrument setting	Default value
Contrast	As defined and stored by adjustment procedure
Z factor	0.8
Supply system	TN / TT
RCD standards	BS 7671
COM port	RS 232
Language	English

Function Sub-function	Parameter / limit value
CONTINUITY General 200 mA General 7 mA R2 R1+R2	R2, PLUG High limit resistance value: OFF High limit resistance value: OFF PLUG, High limit resistance value: OFF PLUG, High limit resistance value: OFF
RING CONTINUITY	R1+RN, Universal
INSULATION	Nominal test voltage: 500 V Low limit resistance value: OFF Selected test leads combination: L-N
Z - LINE ΔU	Fuse type: none selected Limit: 4.0 % $Z_{ref} : 0.00 \Omega$
Z - LOOP	Protection: Fuse Fuse type: none selected
2 Ω line/loop impedance	m Ω L-N Fuse type: none selected
RCD	RCD t Nominal differential current: $I_{\Delta N}=30$ mA RCD type: G Test current starting polarity:  (0°) Limit contact voltage: 50 V Current multiplier: $\times 1$
Earth resistance Specific resistance	Limit value: OFF Distance unit: m
Varistor test	Lo limit: 300 V Hi limit: 400 V

Other settings

F2	Enters menu to unlock the protected auto sequences and comments and/or select distance unit for specific earth resistance measurement.
-----------	--

Unlock protected sequences or distance unit can be selected.

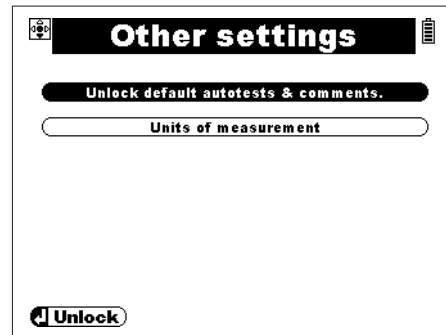

Figure 4.28: Other settings dialogue

Keys:

↑ / ↓	Select other settings item.
TEST	Enters selected item.
ESC	Exits the menu without changes.

Unlocking autotests and comments

Protection flag (key) for all default auto test sequences and associated comments will be cleared.

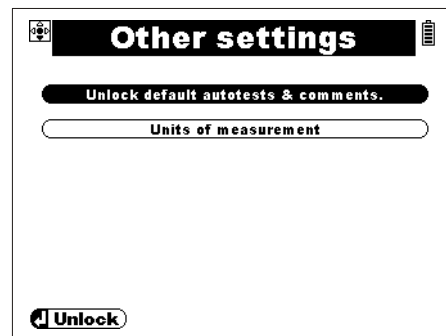

Figure 4.29: Other settings dialogue

TEST	Unlocks locked auto test sequences.
ESC	Exits the menu without changes.

Units selection

Unit for specific earth resistance will be selected.

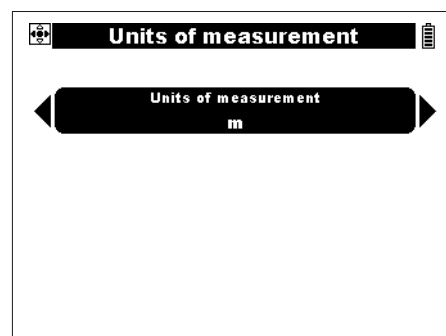

Figure 4.30: Other settings dialogue

← / →	Select distance units.
TEST	Enters selected distance units.
ESC	Exits the menu without changes.

4.4.6 Communication port

The communication port (RS232 or USB) can be selected in this menu.



Figure 4.31: Communication port selection

Keys:

↑ / ↓	Select communication port.
TEST	Confirms selected port.
ESC	Exits without changes.

Note:

- Only one port can be active at the same time.

4.4.7 Locator

This function enables tracing electrical lines.

Keys:

TEST	Starts locator function.
ESC	Stops locator function and exits into miscellaneous menu.

See chapter 5.10 *Locator* for locator operation.

4.4.8 Operator

This menu enables registering the operator of the instrument. Selected operator name appears on the bottom of the LCD during turning on of the instrument. It is also associated to stored measurement results. Up to 5 operators can be defined.

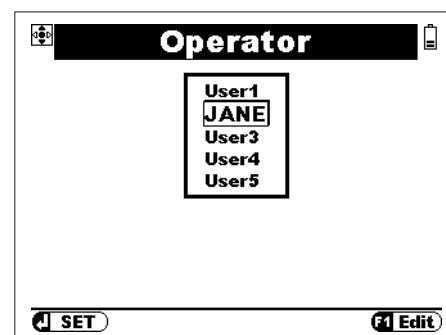

Figure 4.32: Operator menu

Keys:

↑ / ↓	Select operator.
TEST	Accepts selected operator.
ESC	Exits to miscellaneous menu without changes.
F1	Enters operators name edit menu.

Operators name can be entered or modified.

Maximum 15 characters can be entered for operator.

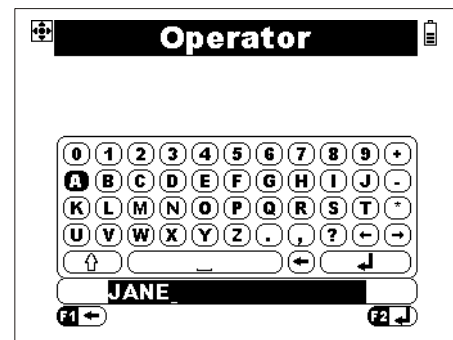

Figure 4.33: Operator name edit menu

Keys:

Highlighted key	Selected symbol or activity.
← / → / ↓ / ↑	Select symbol or activity.
TEST	Enters selected symbol or performs selected activity.
F1	Deletes last entered symbol in the name line.
F2	Confirms comment and returns to operator main menu.
ESC	Deletes operator (immediately after entering the editor). Returns to operator main menu without changes.

5 Measurements

5.1 Inspections

This function is intended to support visual inspections of tested installation or installation assemblies. Result flags for each individual item can be set.

See chapter 4.2 *Inspection* for functionality of keys in Main inspection menu.



Figure 5.1: Inspections menu

Inspection schedules

Item	Schedule type [Full schedule, Domestic schedule, Functional inspection]
------	---

Further keys are active after starting inspection:

F2	Clears all flags in selected schedule.
↓ / ↑	Select individual item in selected schedule.
← / →	<i>Selected header line:</i> Apply same flag to all items in selected header.
	<i>Selected particular item:</i> Apply appropriate result (flag) to selected item.

Inspection procedure

- Select the **INSPECTION** function.
- Select **Schedule** type.
- Press **TEST** key to start inspection.
- Browse through items line by line and apply appropriate flags.
- Press **TEST** or **ESC** key to stop inspection.
- Store** the result (optional).

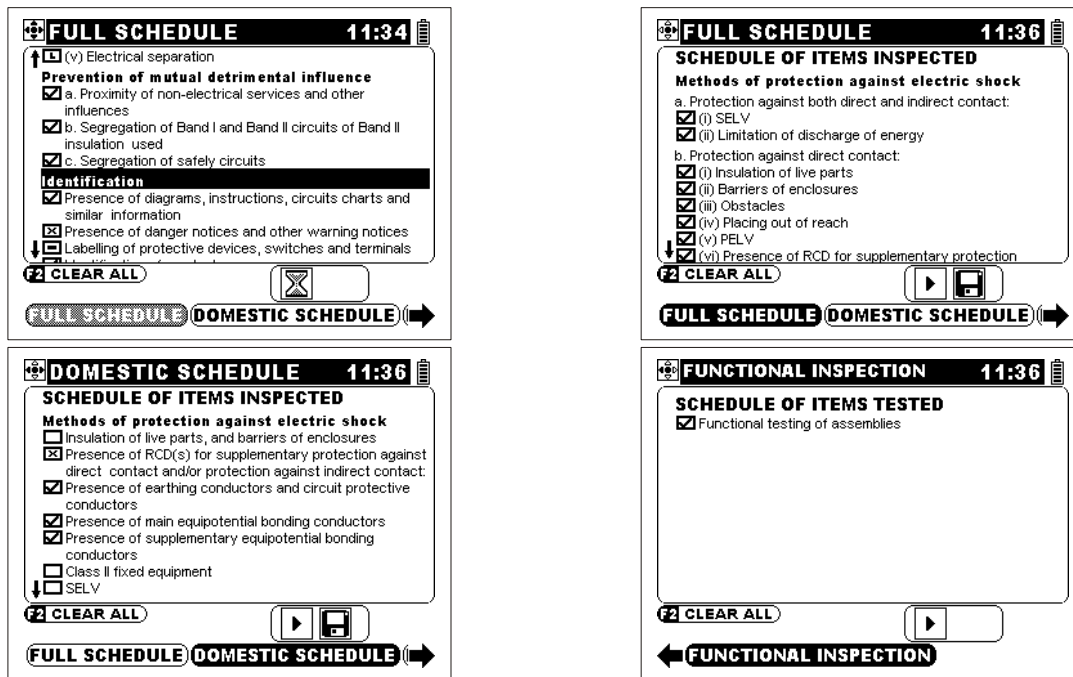

Figure 5.2: Examples of results

Markings:

-Inspection was not performed
-Inspection passed.
-Inspection failed.
-Inspection was performed in limited extent.
-Inspection was not applicable

5.2 Insulation resistance

Insulation resistance measurement is performed in order to assure safety against electric shock through insulation. It is covered by the EN 61557-2 standard. Typical applications are:

- ❑ Insulation resistance between conductors of installation,
- ❑ Insulation resistance of non-conductive rooms (walls and floors),
- ❑ Insulation resistance of ground cables,
- ❑ Resistance of semi-conductive (antistatic) floors.

See chapter 4.2 *Single test* for functionality of keys.

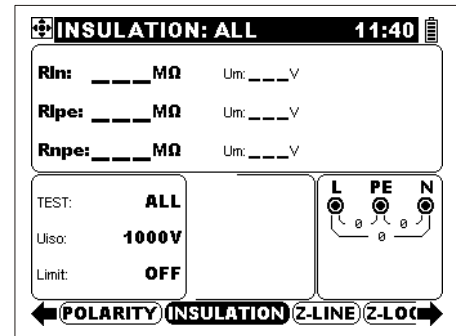

Figure 5.3: Insulation resistance

Test parameters for insulation resistance measurement

TEST	Test configuration [L-N, L-PE, N-PE, ALL, 'L-PE,N-PE', 'L-N,L-PE', L1-L2, L1-L3, L2-L3, All 3ph]
Uiso	Test voltage [50 V, 100 V, 250 V, 500 V, 1000 V]
Limit	Minimum insulation resistance [OFF, 0.1 MΩ ÷ 200 MΩ, ('L-PE,N-PE', 'L-N,L-PE', ALL: 20 MΩ)]

Test circuits for insulation resistance

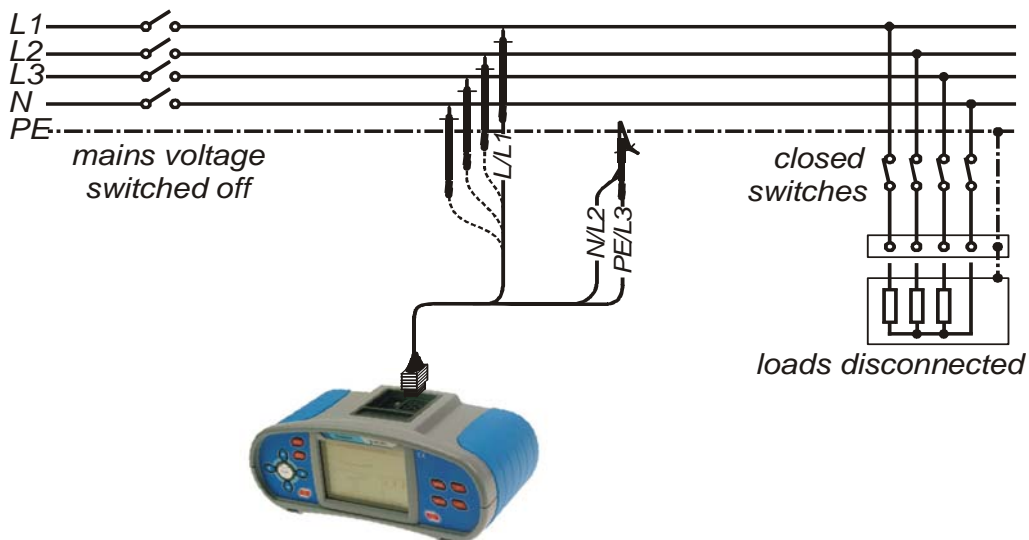

Figure 5.4: Connection of universal test cable for general insulation resistance measurement (TEST: L-PE)

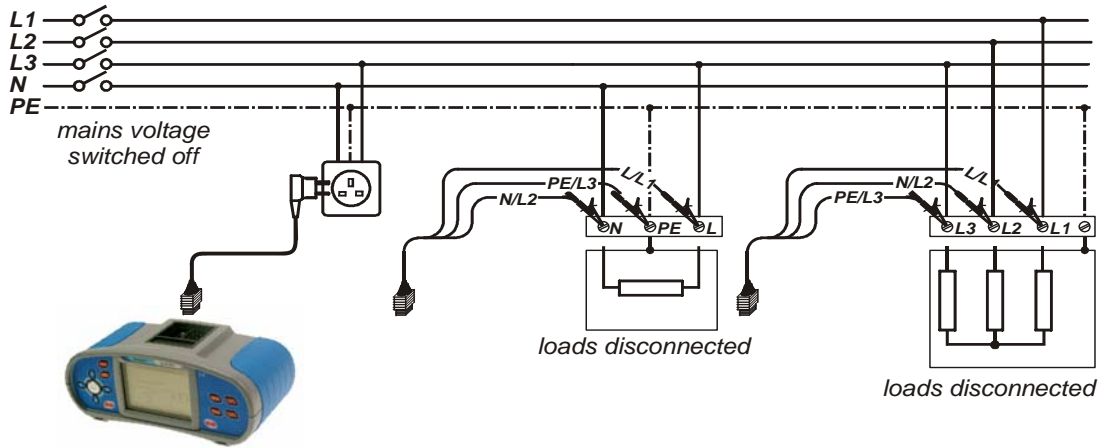

Figure 5.5: Connection of plug cable and universal test cable for insulation resistance measurement (TESTS: 'L-PE,N-PE', 'L-N,L-PE', ALL; L1-L2, L1-L3, L2-L3, All 3ph)

Insulation resistance measuring procedure

- ❑ Select the **INSULATION** function.
- ❑ Set test **parameters**.
- ❑ Enable and set **limit** value (optional).
- ❑ **Disconnect** tested installation from mains supply (and discharge tested insulation).
- ❑ **Connect** test cable to the instrument and tested item (see figures 5.4 and 5.5).
- ❑ Press the **TEST** key for measurement (keep pressing for continuous measurement).
- ❑ After the measurement is finished wait until tested item is discharged.
- ❑ **Store** the result (optional).

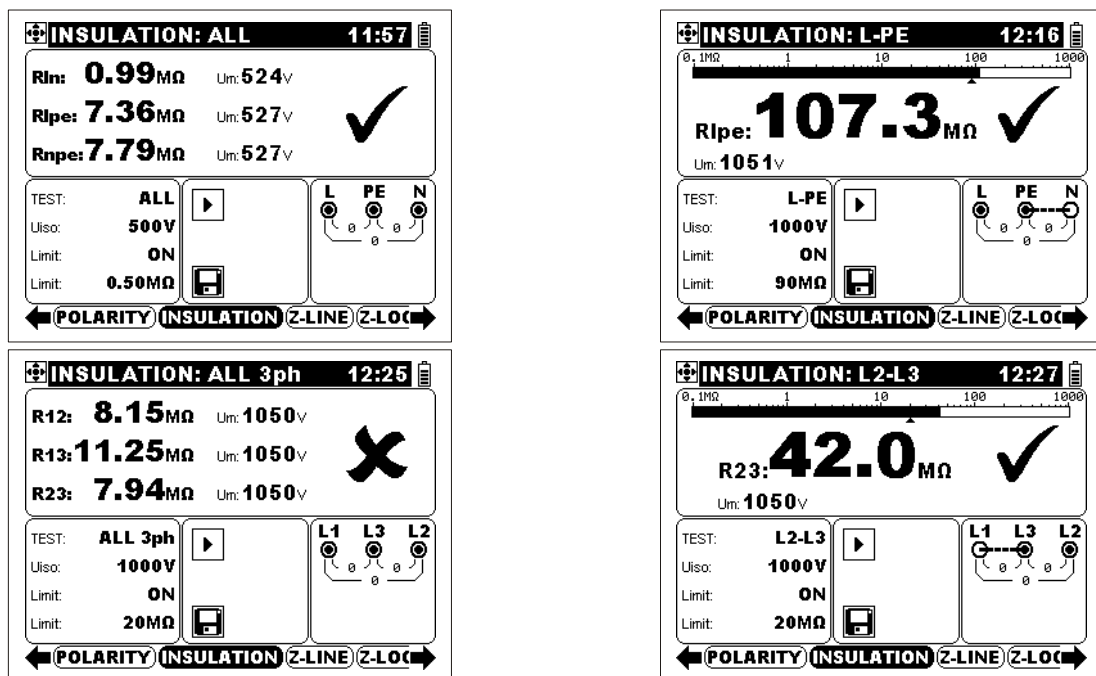

Figure 5.6: Examples of insulation resistance measurement results

Displayed results:

- RInInsulation resistance between L (+) and N (-).
- RlpeInsulation resistance between L (+) and PE (-).
- RnpeInsulation resistance between N (+) and PE (-).
- R12Insulation resistance between L1 (+) and L2 (-).
- R13Insulation resistance between L1 (+) and L3 (-).
- R23Insulation resistance between L2 (+) and L3 (-).
- UmTest voltage(s) – actual value(s).

Note:

- Follow the correct test wiring as indicated in terminal voltage monitor when the particular insulation test is selected. If only two test wires are connected, and L-N, L-PE or N-PE test is selected, then technical specification for INSULATION ALL applies.



5.3 General resistance measurements (including continuity of star circuit connections)

The resistance measurement is performed in order to assure that protective measures against electric shock through earth bond connections are effective. The following sub-functions are available:

- Earth bond resistance measurement according to EN 61557-4 (200 mA),
- Continuous resistance measurement with low test current (7mA),
- Earth bond resistance measurements (R2, R1+R2) for star circuit connection.

See chapter 4.2 *Single test* for functionality of keys.

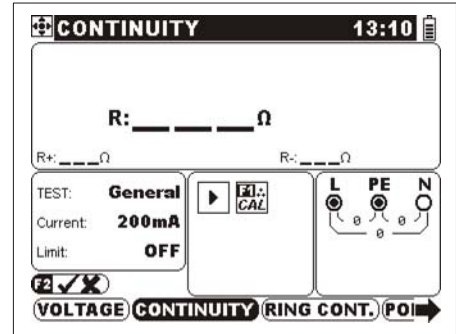

Figure 5.7: Continuity



Additional key:

F2	If limit is set to OFF then manual PASS or FAIL can be applied.
-----------	---

Test parameters for resistance measurement

TEST	Resistance measurement sub-function [R2, R1+R2, General]
Limit	Maximum resistance [OFF, 0.1 Ω ÷ 20.0 Ω]
If General is set	
Current	Test current [7 mA, 200 mA]

5.3.1 Compensation of test leads resistance

This chapter describes common principle for compensation of test leads resistance for CONTINUITY, RING CONTINUITY and POLARITY functions. The compensation is required to eliminate the influence of test leads resistance plus internal resistances of the instrument. The lead compensation is very important to obtain correct result. The compensation status ( / ) is indicated in the message field.

Key:

F1	Enters test leads resistance compensation menu for any of mentioned functions.
-----------	--

See chapter 4.2 *Single test* for functionality of keys.

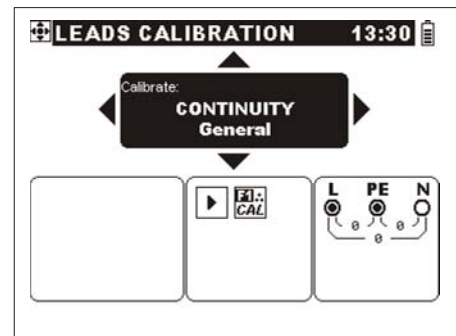







Figure 5.8: Test leads resistance compensation menu

Additional active keys:

TEST	Executes selected calibration.
↓ / ↑	Select sub-function to compensate.
← / →	Select function to compensate.

The instrument contains various test leads resistance compensations intended for:

	Star circuit R2 measurement.	<i>Short L and PE terminals.</i>
	Star circuit R1+R2 measurement.	<i>Short L and PE terminals.</i>
	General, 7 mA or 200 mA measurement.	<i>Short L and PE terminals.</i>
	Polarity measurements.	<i>Short L and PE terminals.</i>
	Ring continuity measurement.	<i>Short L, N and PE terminals.</i>

All five compensations are independent from each other.

Circuits for compensating the resistance of test leads

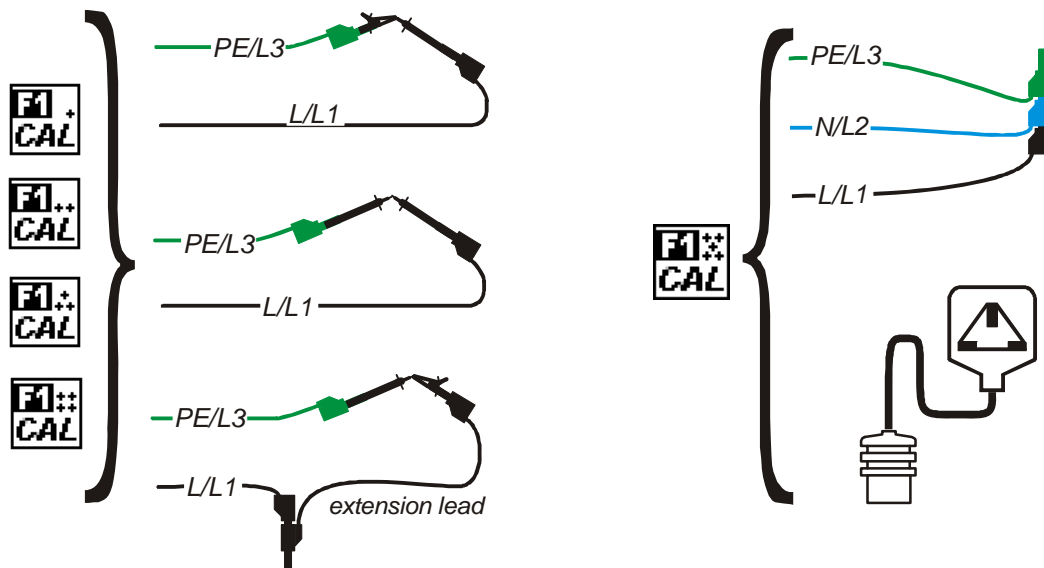

Figure 5.9: Shorted test leads

Compensation of test leads resistance procedure

- ❑ Select the **CONTINUITY** or **RING CONT.** or **POLARITY** function (any).
- ❑ **Connect** test cable to the instrument and short terminals (see figure 5.9).
- ❑ Press the **F1** key to open test leads resistance compensation menu.
- ❑ Select appropriate sub-function for compensation.
- ❑ Press the **TEST** key for measurement and compensation of test leads resistance.
- ❑ Press the **ESC** key to return to function menu.

Note:

- ❑ 20 Ω is limit value for test leads resistance compensation.

5.3.2 General 200 mA measurement

The resistance measurement is performed with automatic polarity reversal of the test voltage.

Test circuit for General 200 mA measurement

MPEC....Main Potential Equilizing Collector
PCC....Protection Conductor Collector

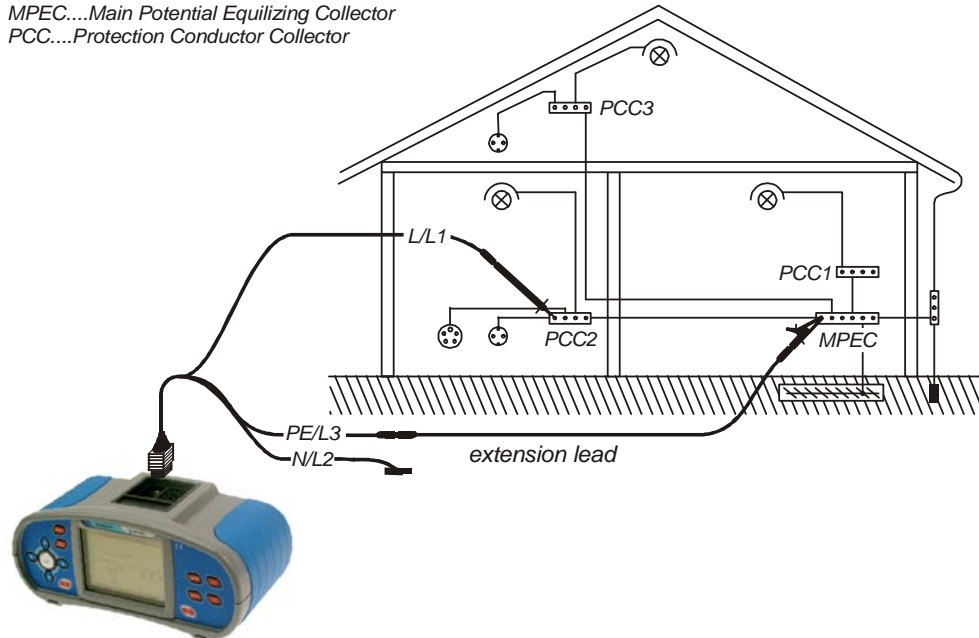

Figure 5.10: Connection of universal test cable plus optional extension lead

General 200 mA resistance measurement procedure

- ❑ Select the **CONTINUITY** function.
- ❑ Set sub-function **General**.
- ❑ Select test current **200 mA**.
- ❑ Enable and set **limit** (optional).
- ❑ **Connect** test cable to the instrument.
- ❑ **Compensate** test leads resistance (if necessary, see chapter 5.3.1).
- ❑ **Disconnect** from mains supply and discharge tested installation.
- ❑ **Connect** test leads to the tested PE wiring (see figure 5.10).
- ❑ Press the **TEST** key for measurement.
- ❑ Apply manual PASS/FAIL (optional).
- ❑ After the measurement is finished **store** the result (optional).

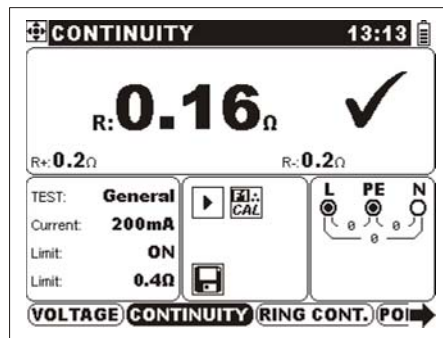

Figure 5.11: Example of continuity, general 200mA result

Displayed results:

- R.....Main resistance result (average of R+ and R- results),
- R+.....Resistance with positive voltage at N terminal,
- R-Resistance with positive voltage at PE terminal.

5.3.3 7 mA resistance measurement

In general this function serves as standard Ω -meter with low test current. The measurement is performed continuously with no pole reversal. The function can be applied for testing continuity of inductive components.

Note:

- This test does not conform to BS7671 regulations!

Test circuit for continuous resistance measurement

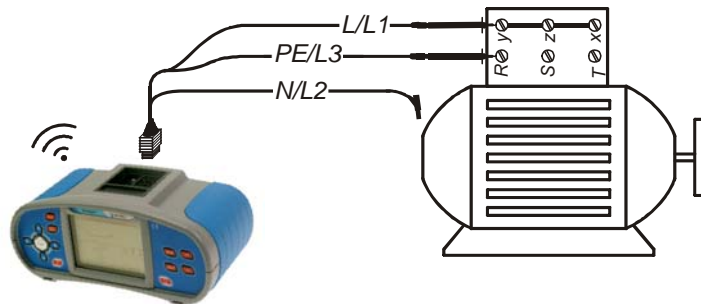

Figure 5.12: Universal test cable application

Continuous resistance measurement procedure

- Select the **CONTINUITY** function.
- Set sub-function **General**.
- Select test current **7 mA**.
- Enable and set **limit** (optional).
- **Connect** test cable to the instrument.
- **Compensate** test leads resistance (if necessary, see chapter 5.3.1).
- **Disconnect** from mains supply and discharge tested object.
- **Connect** test leads to the tested object (see figure 5.12).
- Press the **TEST** key for continuous measurement.
- Press the **TEST** key to stop measurement.
- Apply manual PASS/FAIL (optional).
- After the measurement is finished **store** the result (optional).

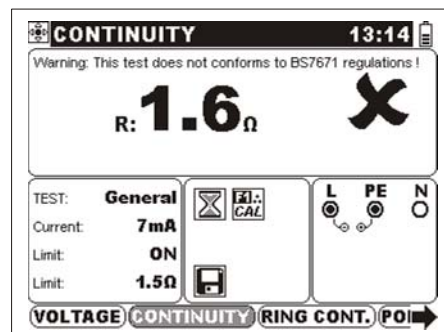

Figure 5.13: Example of 7 mA resistance measurement

Displayed result:

R.....Resistance.

5.3.4 Star circuit resistance R2 measurement

Measurement of the resistance of protective conductors (R2) is performed with automatic polarity reversal of the test voltage.

Test circuit for R2 resistance measurement

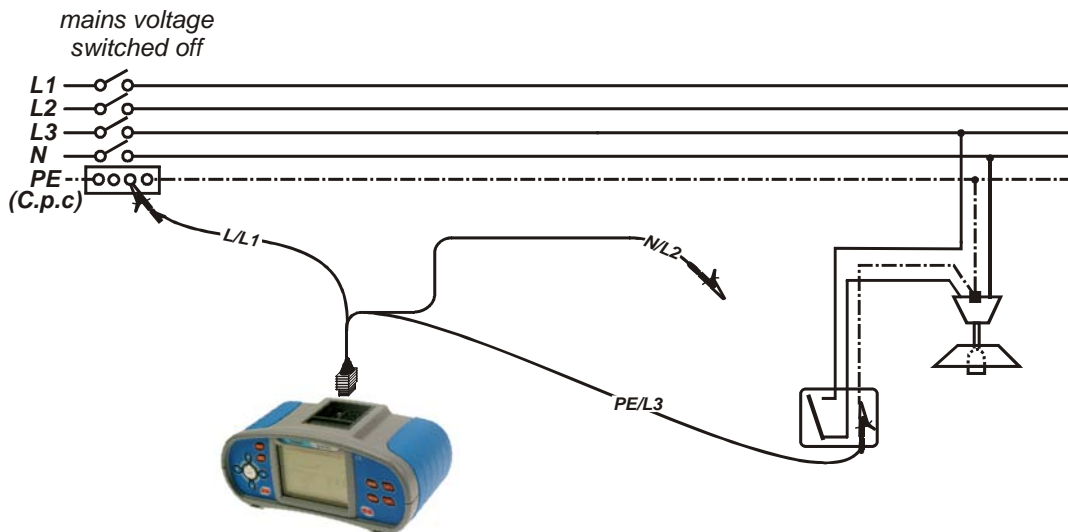

Figure 5.14: Measurement resistance of PE (C.p.c) connection (R2)

Star circuit resistance R2 measurement procedure

- ❑ Select the **CONTINUITY** function.
- ❑ Set sub-function **R2**.
- ❑ Select measuring **cable**.
- ❑ Enable and set **limit** (optional).
- ❑ **Connect** test cable to the instrument.
- ❑ **Compensate** test leads resistance (if necessary, see chapter 5.3.1).
- ❑ **Disconnect** from mains supply and discharge tested installation.
- ❑ **Connect** test cable to the tested wiring (see figure 5.14).
- ❑ Press the **TEST** key for measurement.
- ❑ Apply manual PASS/FAIL (optional).
- ❑ After the measurement is finished **store** the result (optional).

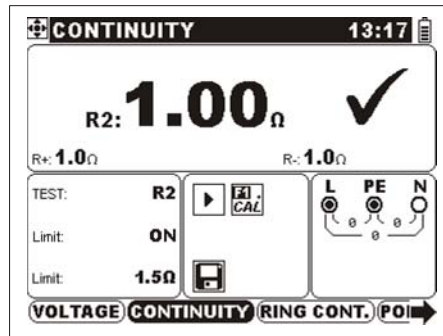

Figure 5.15: Example of star circuit R2 measurement result

Displayed results:

R2.....Main result for resistance R2 (average of R+ and R- results),

R+.....R2 resistance with positive voltage at N terminal,

R-R2 resistance with positive voltage at PE terminal.

5.3.5 Star circuit R1+R2 measurement

Measurement of sum of resistance of phase and protective conductors in final circuit, (R1+R2), is performed with automatic polarity reversal of the test voltage.

Test circuit for R1+R2 resistance measurement

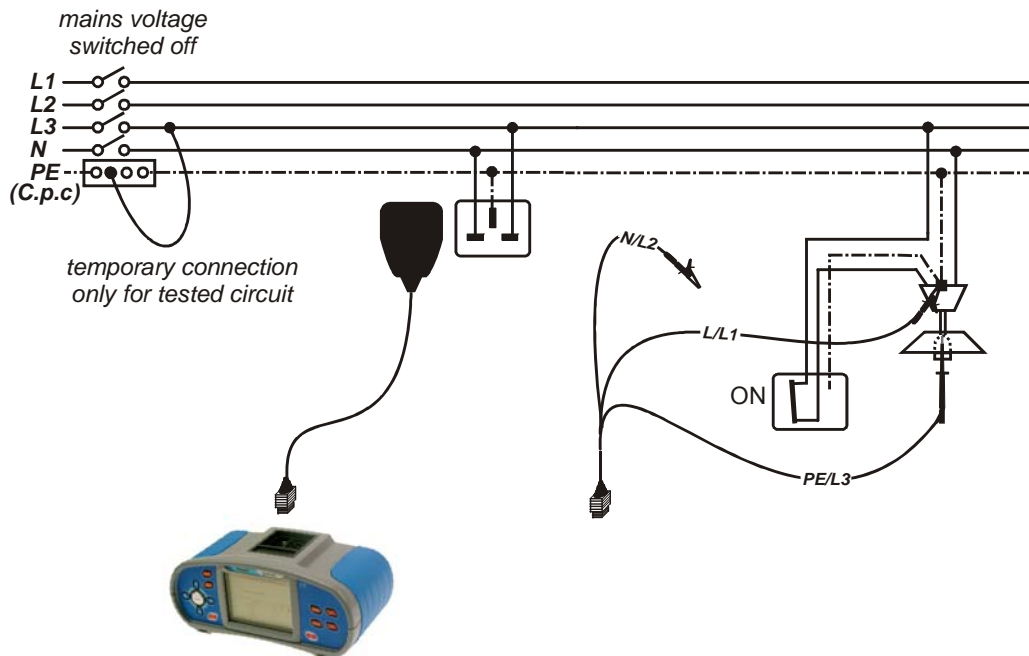

Figure 5.16: Measurement resistance of L – PE loop (R1+R2) using plug and universal test cable

Star circuit resistance R1+R2 measurement procedure

- ❑ Select the **CONTINUITY** function.
- ❑ Set sub-function **R1+R2**.
- ❑ Select measuring **cable**.
- ❑ Enable and set **limit** (optional).
- ❑ **Connect** test cable to the instrument.
- ❑ **Compensate** test leads resistance (if necessary, see chapter 5.3.1).
- ❑ **Disconnect** tested installation from mains supply.
- ❑ **Connect** test cable to the tested wiring (see figure 5.16).
- ❑ Press the **TEST** key for measurement.
- ❑ Apply manual PASS/FAIL (optional).
- ❑ After the measurement is finished **store** the result (optional).

Note:

- ❑ Temporary link must be provided between L and PE at the distribution board!

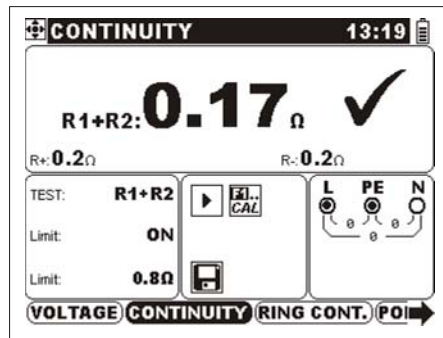

Figure 5.17: Example of star circuit R1+R2 measurement result

Displayed results:

- R1+R2 Main result for resistance R1+R2 (average of R+ and R- results),
- R+ R1+R2 resistance with positive voltage at phase terminal,
- R- R1+R2 resistance with positive voltage at PE terminal.

5.4 Continuity in ring final circuits

Special resistance measurements are intended for checking connections in ring final circuits as defined in BS 7671.

See chapter 4.2 *Single test* for functionality of keys.

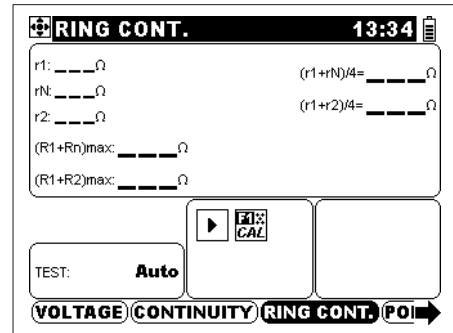

Figure 5.18: Ring continuity

Additional active keys:

F1	Commits result to selected position. Clears result on selected position if there is no result (---Ω).
F2	Applies PASS / FAIL to result.

Test parameters for ring final circuit resistances measurement

TEST	Ring resistance measurement sub-function [Auto, R1+RN, R1+R2]
------	--

5.4.1 Ring circuit resistance R1+R2 measurement

The resistance measurement is performed to measure sum of resistances of line and PE conductors in ring final circuit.

Test circuits for R1+R2 resistance measurement

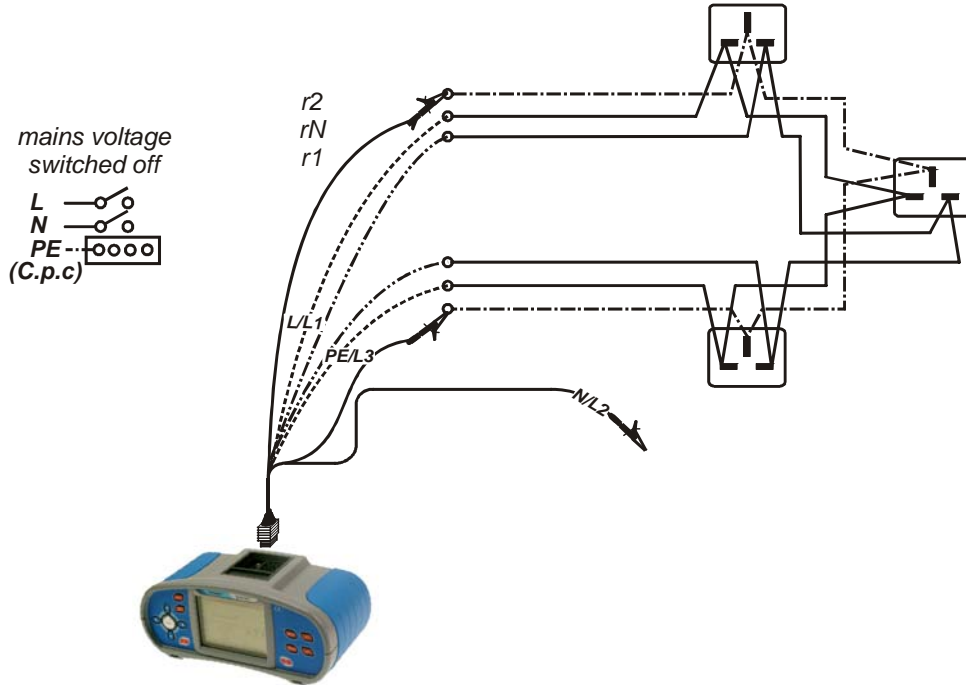

Figure 5.19: Step 1 – measurement of resistances r1, rN and r2

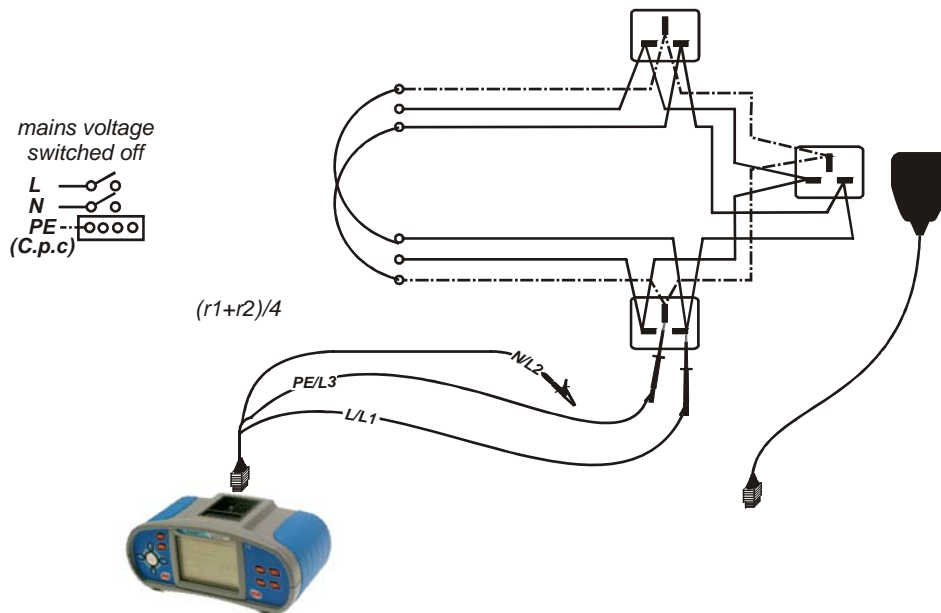

Figure 5.20: Verification of wall sockets of tested final ring circuit using universal or plug cable

Ring continuity, R1+R2 resistance measurement procedure

1. step: Ring continuity - r1, rN, r2 resistance measurement procedure

- ❑ Select the **RING CONT** function.
- ❑ Set sub-function **R1+R2**.
- ❑ Select measuring **cable**.
- ❑ **Connect** test cable to the instrument.
- ❑ **Disconnect** tested installation from mains supply.
- ❑ **Compensate** test leads resistance (if necessary, see chapter 5.3.1).
- ❑ Press the **TEST** key for measurements.
- ❑ Press the key **↑**.
- ❑ For r1, rN, r2 measurements refer to figure 5.19.
- ❑ Perform measurement between both ends of phase conductor.
- ❑ Commit result (F1 key) to r1.
- ❑ Perform measurement between both ends of neutral conductor.
- ❑ Commit result (F1 key) to rN.
- ❑ Perform measurement between both ends of PE conductor.
- ❑ Commit result (F1 key) to r2.
- ❑ Press the key **↓**.

From r1, rN and r2 results reference values for R1+RN, R1+R2 are calculated. The results are kept until they are changed or cleared.

2. step: Ring continuity - R1+R2 resistance measurement procedure

- ❑ **Cross-connect** line and protective conductors of tested ring circuit (see *figure 5.20*).
- ❑ Press the **TEST** key for measurement of the first socket of tested ring final circuit (see *figure 5.20*).
- ❑ For correct ring wiring the result must be approximately the same as reference value $(r1+r2)/4$.
- ❑ Commit result (F1 key) to $(R1+R2)_{max}$ position.
- ❑ Perform measurement on next socket.
- ❑ Commit result (F1 key) to $(R1+R2)_{max}$ position. The result will be committed only if the result is higher than the previous one.
- ❑ Repeat last two steps on all sockets of the circuit. For correct ring wiring all results must be approximately the same as displayed $(r1+r2)/4$.
- ❑ Resistance slightly increases with length if cross section of PE conductor is smaller than of line conductor.
- ❑ **Press** the **F2** key to apply manual pass/fail of the result (optional).
- ❑ Press the **ESC** key to exit the measurement.
- ❑ After the measurement is finished **store** the result (optional).

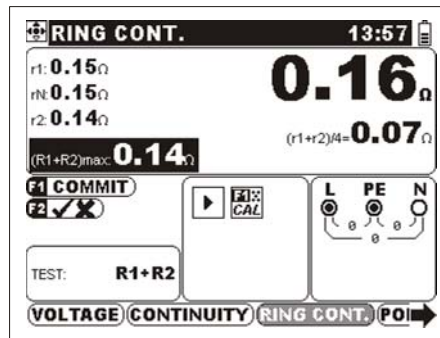

Figure 5.21: Example of ring continuity R1+R2 results

Displayed results:

- r1 Ring resistance of line conductors,
- rN Ring resistance of neutral conductors,
- r2 Ring resistance of PE conductors (C.p.c.),
- (R1+R2)max.. Reference test value,
- (r1+r2)/4 Calculated reference value.

5.4.2 R1+RN measurement

The resistance measurement is performed with time limited continuous resistance measurement.

Test circuit for R1+RN resistance measurement

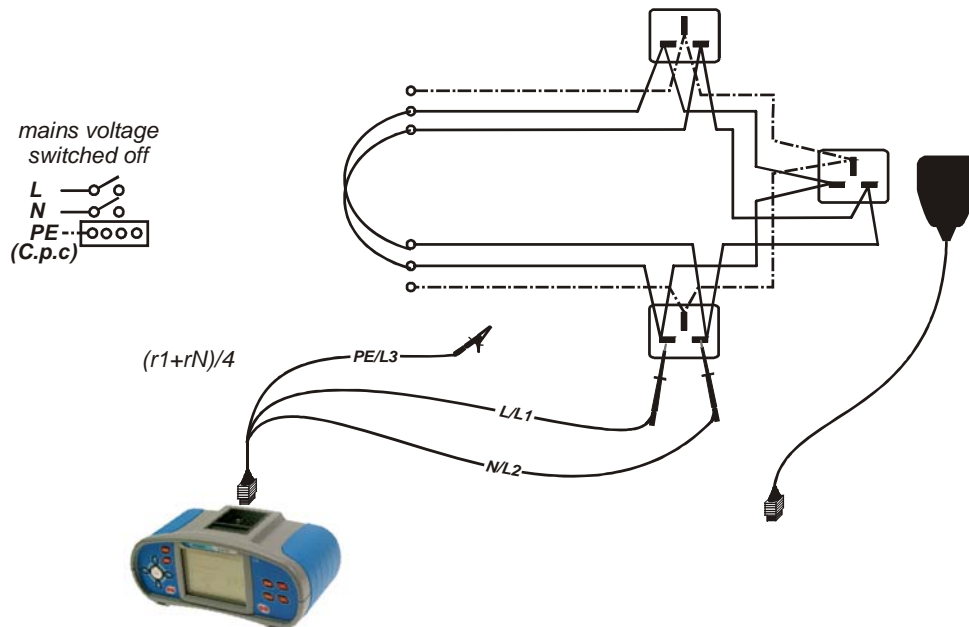

Figure 5.22: Verification of wall sockets of tested ring final circuit using universal or plug cable

Ring continuity, R1+RN resistance measurement procedure

1. step: Ring continuity - r_1 , r_N , r_2 resistance measurement procedure

- ❑ Select the **RING CONT.** function.
- ❑ Set sub-function **R1+RN**.
- ❑ Select measuring **cable**.
- ❑ **Connect** test cable to the instrument.
- ❑ **Disconnect** tested installation from mains supply.
- ❑ **Compensate** test leads resistance (if necessary, see chapter 5.3.1).
- ❑ Press the **TEST** key for measurements.
- ❑ Press the key **↑**.
- ❑ For the following measurements refer to figure 5.19.
- ❑ Perform measurement between both ends of line conductor.
- ❑ Commit result (F1 key) to r_1 .
- ❑ Perform measurement between both ends of neutral conductor.
- ❑ Commit result (F1 key) to r_N .
- ❑ Perform measurement between both ends of PE conductor.
- ❑ Commit result (F1 key) to r_2 .
- ❑ Press the key **↓**.

From r_1 , r_N and r_2 results reference values for $R1+RN$, $R1+R2$ are calculated. The results are kept until they are changed or cleared.

2. step: Ring continuity - R1+RN resistance measurement procedure

- ❑ **Cross-connect** line and neutral conductors of tested ring circuit (see *figure 5.22*).
- ❑ Press the **TEST** key for measurement of the first socket of tested ring final circuit (see *figure 5.22*).
- ❑ For correct ring wiring the result must be approximately the same as reference value $(r1+rN)/4$.
- ❑ Commit result (F1 key) to $(R1+Rn)_{max}$ position.
- ❑ Perform measurement on next socket.
- ❑ Commit result (F1 key) to $(R1+Rn)_{max}$ position. The result will be committed only if the result is higher than the previous one.
- ❑ Repeat last two steps on all sockets of the circuit. For correct ring wiring all result must be approximately the same as displayed $(r1+rN)/4$.
- ❑ **Press** the **F2** key to apply manual pass/fail of the result (optional).
- ❑ Press the **ESC** key to exit the measurement.
- ❑ After the measurement is finished **store** the result (optional).

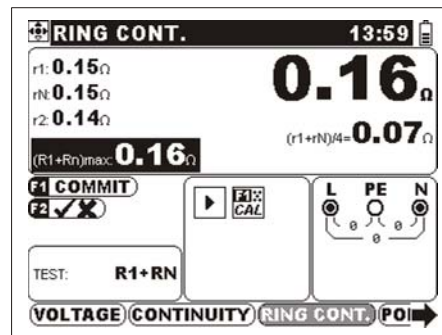

Figure 5.23: Example of ring continuity R1+RN results

Displayed results:

- r1 Ring resistance of line conductors,
- rN Ring resistance of neutral conductors,
- r2 Ring resistance of PE conductors (C.p.c.),
- (R1+Rn)max.. Reference test value,
- $(r1+rN)/4$ Calculated reference value.

5.4.3 Auto measurement

With Ring adapter A1214 the ring resistance measurements can be simplified. The unit automatically cares for correct connectivity at the switchboard. R1+R2 and R1+RN measurements can be performed in one go.

Test circuits for Auto resistance measurement

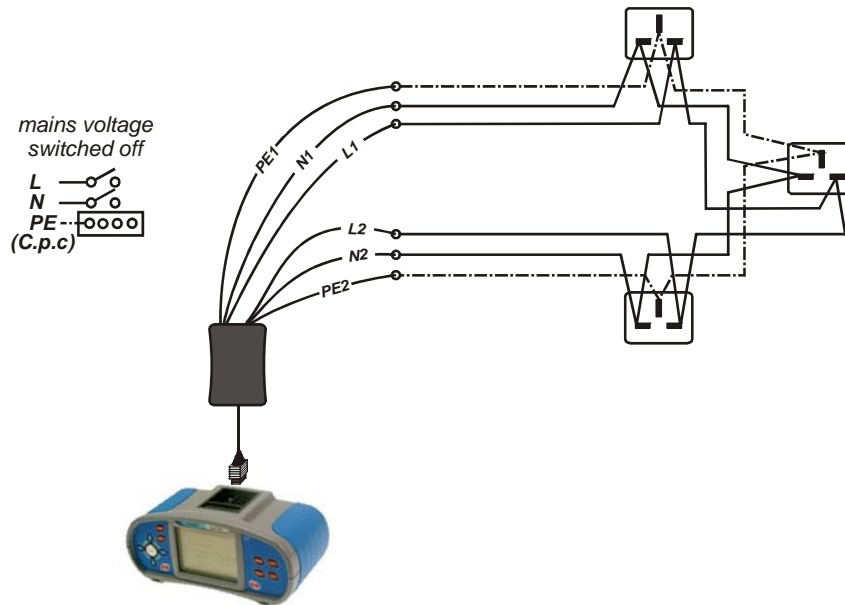

Figure 5.24: 1. step - measurement resistances r_1 , r_N and r_2

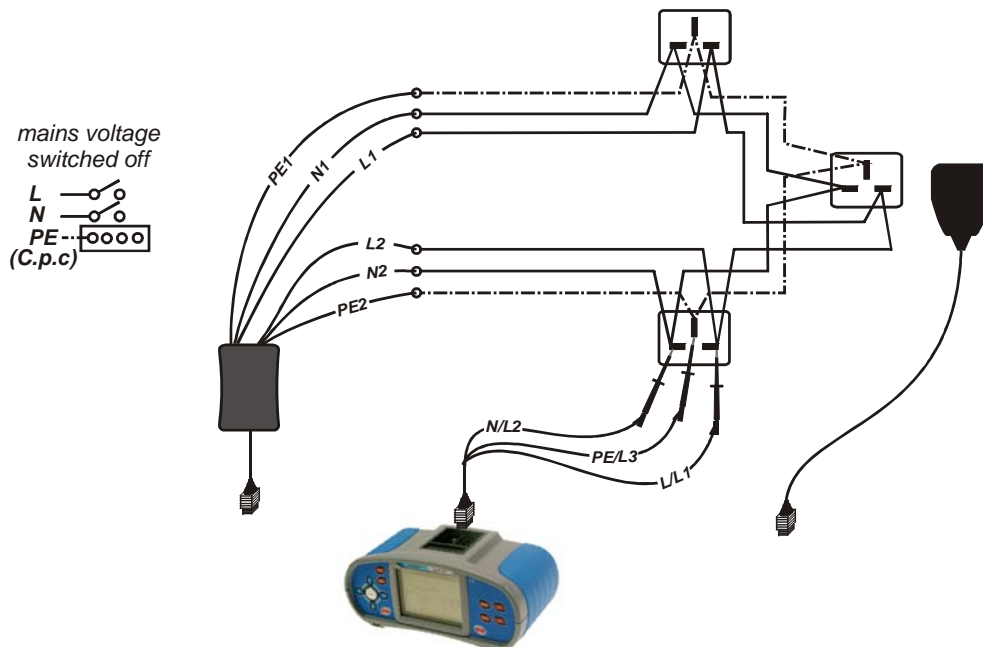

Figure 5.25: Verification of wall sockets of tested ring final circuit using universal or plug cable

Ring continuity, Auto resistance measuring procedure

1. step: Ring continuity - r1, rN, r2 resistance measuring procedure

- ❑ Select the **RING CONT.** function.
- ❑ Set sub-function **Auto**.
- ❑ **Connect** Ring adapter to the instrument.
- ❑ **Compensate** test leads resistance (if necessary, see chapter 5.3.1).
- ❑ **Disconnect** tested installation from mains supply.
- ❑ **Connect** Ring adapter to the tested installation (see *figure 5.24*).
- ❑ Press the **TEST** key for measurements.
- ❑ Perform measurements of r1, rN, and r2.
- ❑ Commit results (F1 key) to r1, rN, and r2.

From r1, rN and r2 results reference values for R1+RN, R1+R2 are calculated. The results are kept until they are changed or cleared. Take care that measuring leads are compensated.

2. step: Ring continuity - R1+RN, R1+R2 resistance measuring procedure

- ❑ **Disconnect** Ring adapter from the instrument.
- ❑ **Connect** plug cable or test cable to the instrument.
- ❑ Press the **TEST** key for measurements.
- ❑ Perform a measurement on socket (see *figure 5.25*).
- ❑ For correct ring wiring the results must be approximately the same as reference value $(r1+rN)/4$ and $(r1+r2)/4$.
- ❑ The resistance R1+R2 slightly increases with length if cross section of PE conductor is smaller than of line conductor.
- ❑ Commit results (F1 key) to $(R1+Rn)_{max}$ and $(R1+R2)_{max}$ positions.
- ❑ Perform measurement on next socket.
- ❑ Commit results (F1 key) again. The results will be committed only if they are higher as the previous.
- ❑ Repeat last two steps on all sockets of the circuit.
- ❑ **Press** the **F2** key to apply manual pass/fail of the result (optional).
- ❑ Press the **ESC** key to exit the measurement.
- ❑ After the measurement is finished **store** the result (optional).

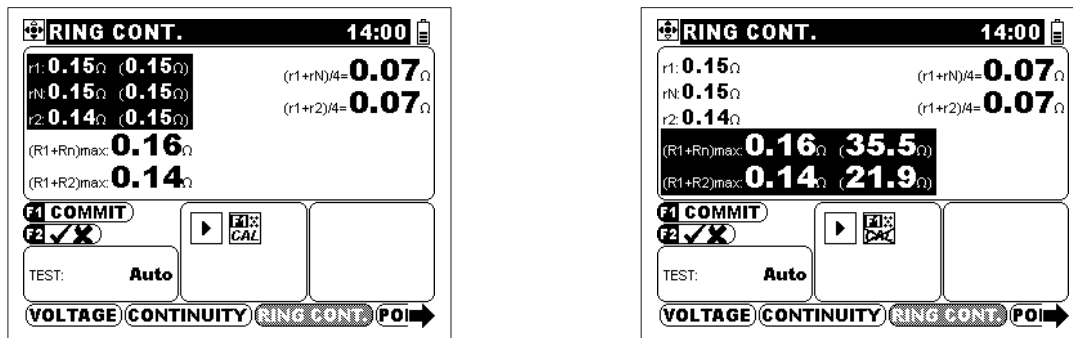

Figure 5.26: Examples of ring continuity - Auto results

Displayed results:

- r1 Ring resistance of line conductors, committed (actual),
- rN Ring resistance of neutral conductors,
- r2 Ring resistance of protective conductors (C.p.c.),
- (R1+Rn)max.. Reference test value,
- (R1+R2)max.. Reference test value,
- (r1+r2)/4 Calculated reference value,
- (r1+rN)/4 Calculated reference value.

Displayed values in brackets are actual (not committed) measuring results.

5.5 Polarity

This function is intended to check proper connections of fuses and other protective devices, lamp holders, socket outlets and similar devices as defined in BS 7671.

See chapter 4.2 *Single test* for functionality of keys.

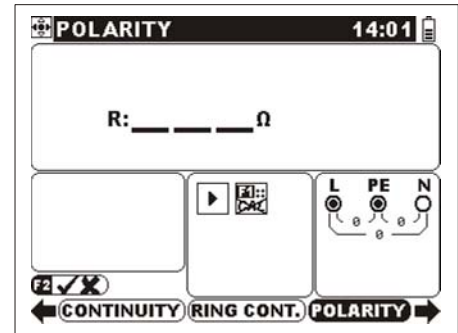

Figure 5.27: Polarity

Additional active key

F2	Applies manual pass / fail indication to test result.
-----------	---

Test parameters for polarity measurement

There are no test parameters.

Procedure for polarity test

- ❑ Select the **POLARITY** function.
- ❑ **Connect** test cable to the instrument.
- ❑ **Compensate** test leads resistance (if necessary, see chapter 5.3.1).
- ❑ **Connect** test cable to the measured object.
- ❑ Press the **TEST** key for continuous measurement.
- ❑ Press the **TEST** key to stop measurement.
- ❑ **Press** the **F2** key to apply manual pass/fail of the result (optional).
- ❑ After the measurement is finished, **store** the result (optional).

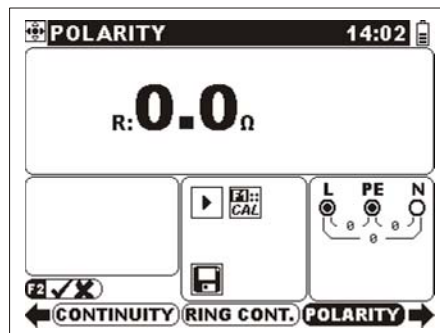

Figure 5.28: Example of polarity test result

Displayed result:

R.....Resistance.

5.6 Testing RCDs

Various test and measurements are required for verification of RCD(s) in RCD protected installations. Measurements are based on the EN 61557-6 standard.

The following measurements and tests (sub-functions) can be performed:

- Contact voltage,
- Trip-out time,
- Trip-out current,
- RCD autotest.

See chapter 4.2 *Single test* for functionality of keys.

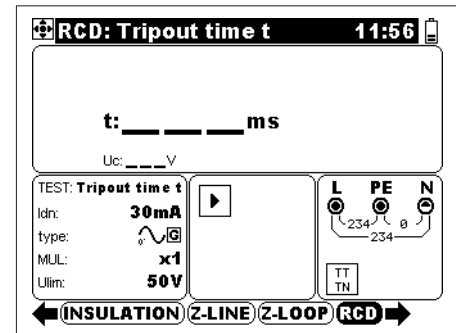

Figure 5.29: RCD test

Test parameters for RCD test and measurement

TEST	RCD sub-function test [Tripout time t, Uc, AUTO, Tripout current].
Idn	Rated RCD residual current sensitivity $I_{\Delta N}$ [10 mA, 30 mA, 100 mA, 300 mA, 500 mA, 1000 mA].
type	RCD type [G , S], test current waveform plus starting polarity [0° , 180° , 0° , 180° , 0° , 180°].
MUL	Actual test current relative to rated Idn [$\frac{1}{2}$, 1, 2, 5].
Ulim	Conventional touch voltage limit [25 V, 50 V].

The instrument is intended for testing of **G**eneral (non-delayed) and **S**elective (time-delayed) RCDs, which are suited for:

- Alternating residual current (AC type, marked with \sim symbol),
- Pulsating residual current (A type, marked with \sim symbol),
- DC residual current (B type, marked with \equiv symbol).

Time delayed RCDs demonstrate delayed response characteristics. They contain residual current integrating mechanism for generation of delayed trip out. However, contact voltage pre-test in the measuring procedure also influences the RCD and it takes a period to recover into idle state. Time delay of 30 s is inserted before performing trip-out test to recover RCD after pretests.

Circuits for testing RCD

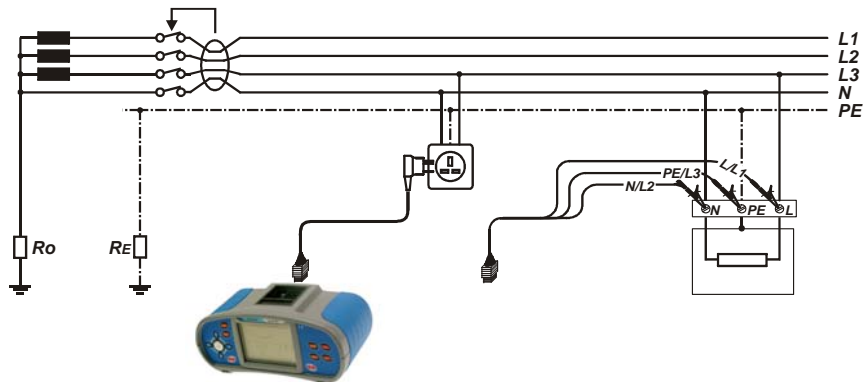

Figure 5.30: Connecting the plug cable and the universal test cable

5.6.1 Contact voltage (RCD Uc)

A current flowing into the PE terminal causes a voltage drop on earth resistance, i.e. voltage difference between PE equipotential bonding circuit and earth. This voltage difference is called contact voltage. The voltage is present on all accessible conductive parts connected to the PE. It should always be lower than the conventional safety limit voltage.

The contact voltage is measured with a test current lower than $\frac{1}{2} I_{\Delta N}$ to avoid trip-out of the RCD and then normalized to the rated $I_{\Delta N}$.

Contact voltage measurement procedure

- Select the **RCD** function.
- Set sub-function **Uc**.
- Set test **parameters** (if necessary).
- Connect** test cable to the instrument.
- Connect** test leads to the tested object (see *figure 5.30*).
- Press the **TEST** key.
- After the measurement is finished **store** the result (optional).

Displayed contact voltage relates to the rated nominal residual current of the RCD and is multiplied by appropriate factor. Common factor of 1.05 is applied to avoid negative tolerance of result, additional depend on RCD type and type of test current. See table 5.1 for detailed contact voltage calculation.

RCD type		Contact voltage U_c proportional to	Rated $I_{\Delta N}$
AC	G	$1.05 \times I_{\Delta N}$	any
AC	S	$2 \times 1.05 \times I_{\Delta N}$	
A	G	$1.4 \times 1.05 \times I_{\Delta N}$	≥ 30 mA
A	S	$2 \times 1.4 \times 1.05 \times I_{\Delta N}$	
A	G	$2 \times 1.05 \times I_{\Delta N}$	< 30 mA
A	S	$2 \times 2 \times 1.05 \times I_{\Delta N}$	
B	G	$2 \times 1.05 \times I_{\Delta N}$	any
B	S	$2 \times 2 \times 1.05 \times I_{\Delta N}$	

Table 5.1: Relationship between U_c and $I_{\Delta N}$

Loop resistance is indicative and calculated from U_c result (without additional proportional factors) according to: $R_L = \frac{U_c}{I_{\Delta N}}$.

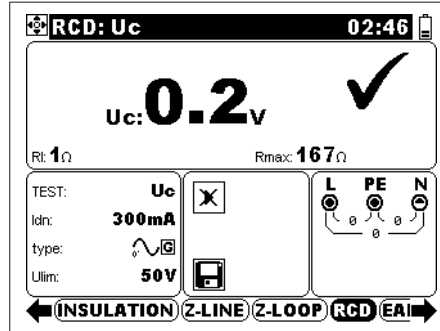

Figure 5.31: Example of contact voltage measurement results

Displayed results:

U_c Contact voltage.

R_l Fault loop resistance.

R_{max} .. Limit earth fault loop resistance value according to BS 7671.

5.6.2 Trip-out time (RCD t)

Trip-out time measurement verifies the sensitivity of an RCD at different residual currents.

Trip-out time measurement procedure

- ❑ Select the **RCD** function.
- ❑ Set sub-function **Tripout time t**.
- ❑ Set test **parameters** (if necessary).
- ❑ **Connect** test cable to the instrument.
- ❑ **Connect** test leads to the tested object (see figure 5.30).
- ❑ Press the **TEST** key.
- ❑ After the measurement is finished **store** the result (optional).

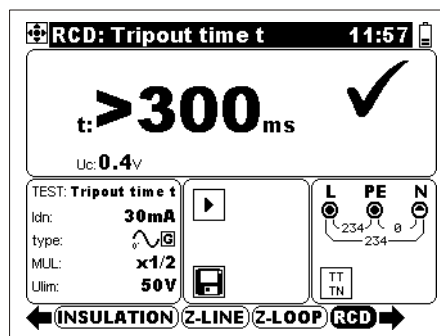

Figure 5.32: Example of trip-out time measurement results

Displayed results:

t Trip-out time,

U_c Contact voltage for rated $I_{\Delta N}$.

Note:

- ❑ See 4.4.2 RCD standard for selection of appropriate standard test conditions.

5.6.3 Trip-out current (RCD I_{Δ})

A continuously rising residual current is intended for testing the threshold sensitivity for RCD trip-out. The instrument increases the test current in small steps through appropriate range as follows:

RCD type	Slope range		Waveform
	Start value	End value	
AC	$0.2 \times I_{\Delta N}$	$1.1 \times I_{\Delta N}$	Sine
A ($I_{\Delta N} \geq 30 \text{ mA}$)	$0.2 \times I_{\Delta N}$	$1.5 \times I_{\Delta N}$	Pulsed
A ($I_{\Delta N} = 10 \text{ mA}$)	$0.2 \times I_{\Delta N}$	$2.2 \times I_{\Delta N}$	
B	$0.2 \times I_{\Delta N}$	$2.2 \times I_{\Delta N}$	DC

Maximum test current is I_{Δ} (trip-out current) or end value of test current in case the RCD didn't trip-out.

Trip-out current measurement procedure

- ❑ Select the **RCD** function.
- ❑ Set sub-function **Tripout current**.
- ❑ Set test **parameters** (if necessary).
- ❑ **Connect** test cable to the instrument.
- ❑ **Connect** test leads to the tested object (see *figure 5.30*).
- ❑ Press the **TEST** key.
- ❑ After the measurement is finished **store** the result (optional).

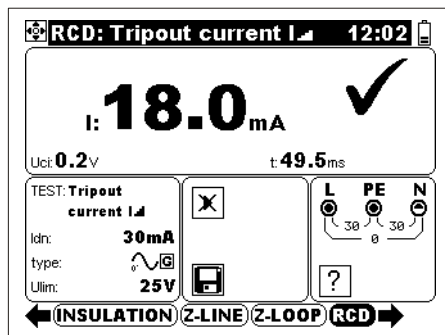

Trip-out

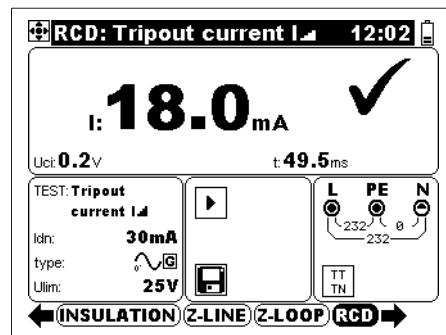

After the RCD is turned on again

Figure 5.33: Trip-out current measurement result example

Displayed results:

I Trip-out current,

Uci Contact voltage at trip-out current I or at end value in case the RCD didn't trip,

t Trip-out time.

5.6.4 RCD Autotest

RCD autotest function is intended to perform complete RCD testing and measurement of belonging parameters (contact voltage, fault loop resistance and trip-out time at different residual currents) in one set of automatic tests, guided by the instrument. If any false parameter is noticed during the RCD autotest, then individual parameter test has to be used for further investigation.

RCD autotest procedure

RCD Autotest steps	Notes
<ul style="list-style-type: none"> ❑ Select the RCD function. ❑ Set sub-function AUTO. ❑ Set test parameters (if necessary). ❑ Connect test cable to the instrument. ❑ Connect test leads to the tested object (see <i>figure 5.30</i>). ❑ Press the TEST key. 	Start of test
<ul style="list-style-type: none"> ❑ Test with $I_{\Delta N}$, 0° (step 1). 	RCD should trip-out
<ul style="list-style-type: none"> ❑ Re-activate RCD. ❑ Test with $I_{\Delta N}$, 180° (step 2). 	RCD should trip-out
<ul style="list-style-type: none"> ❑ Re-activate RCD. ❑ Test with $5 \times I_{\Delta N}$, 0° (step 3). 	RCD should trip-out
<ul style="list-style-type: none"> ❑ Re-activate RCD. ❑ Test with $5 \times I_{\Delta N}$, 180° (step 4). 	RCD should trip-out
<ul style="list-style-type: none"> ❑ Re-activate RCD. 	
<ul style="list-style-type: none"> ❑ Test with $\frac{1}{2} \times I_{\Delta N}$, 0° (step 5-1). 	RCD should not trip-out
<ul style="list-style-type: none"> ❑ Test with $\frac{1}{2} \times I_{\Delta N}$, 180° (step 5-2). 	RCD should not trip-out
<ul style="list-style-type: none"> ❑ After the measurement is finished store the result (optional). 	End of test

Result examples:

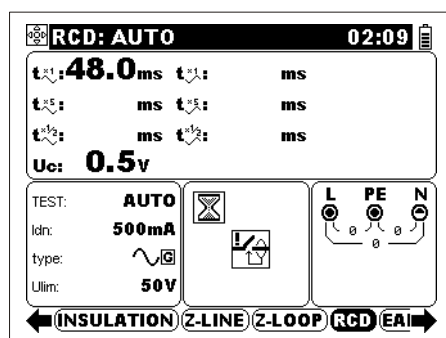

Step 1

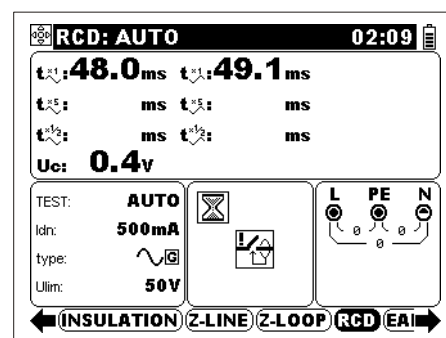

Step 2

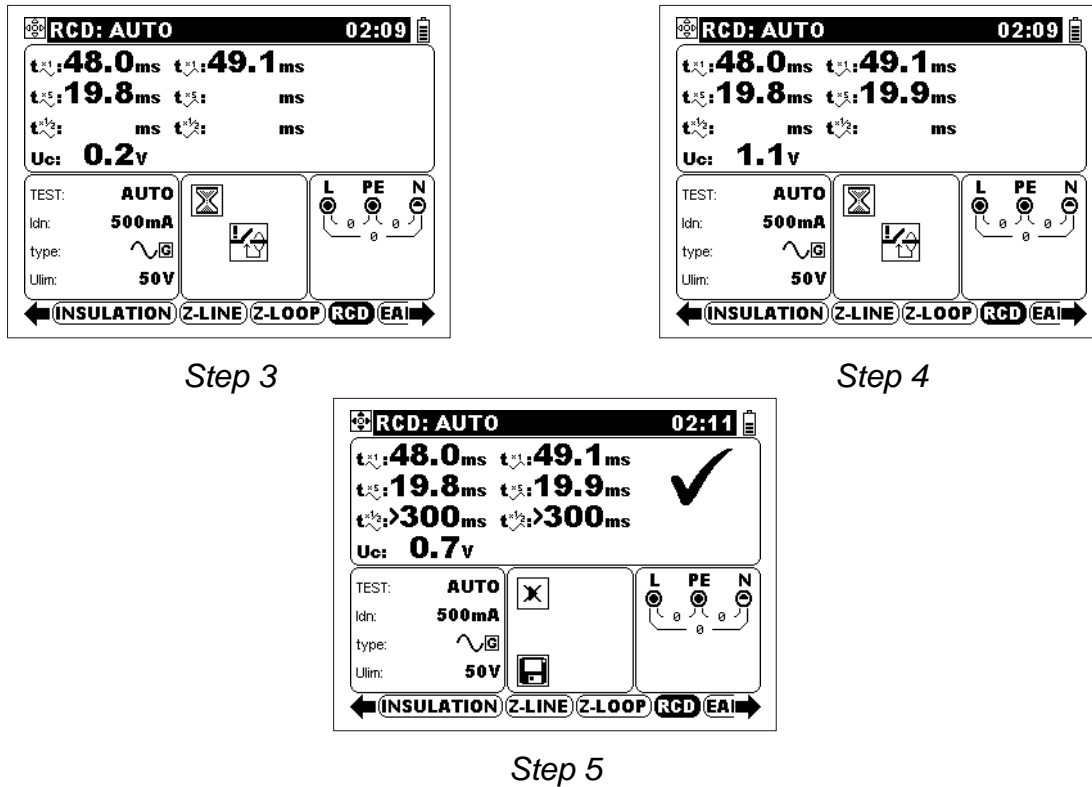

Figure 5.34: Individual steps in RCD autotest

Displayed results:

- t^{x1} : ... Step 1 trip-out time ($I_{\Delta N}$, 0°),
- t^{x2} : ... Step 2 trip-out time ($I_{\Delta N}$, 180°),
- t^{x3} : ... Step 3 trip-out time ($5 \times I_{\Delta N}$, 0°),
- t^{x4} : ... Step 4 trip-out time ($5 \times I_{\Delta N}$, 180°),
- t^{x5} : ... First part of step 5 trip-out time ($\frac{1}{2} \times I_{\Delta N}$, 0°),
- t^{x6} : ... Second part of step 5 trip-out time ($\frac{1}{2} \times I_{\Delta N}$, 180°),
- U_c : ... Contact voltage for rated $I_{\Delta N}$.

Notes:

- The autotest sequence is immediately stopped if any incorrect condition is detected, e.g. excessive U_c or trip-out time out of bounds.
- Auto test is finished without t^{x5} : tests in case of testing the RCD type A with rated residual currents of $I_{\Delta N} = 300 \text{ mA}$, 500 mA , and 1000 mA . In this case auto test result passes if all previous results pass, and indications t^{x5} : and t^{x6} : are omitted.

5.7 Fault loop impedance and prospective fault current

Fault loop is a loop comprising mains source, line wiring and PE return path to the mains source. The instrument has ability to measure impedance of mentioned loop and calculate short circuit current and contact voltage regarding the selected circuit breaker type. The measurement is covered by requirements of the EN 61557-3 standard.

Additional to this, the Zmax function holds the result of maximum fault loop impedance.

See 4.2 Single test for active keys.

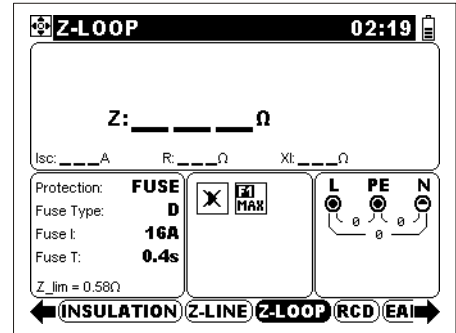

Figure 5.35: Fault loop impedance

Test parameters for fault loop impedance measurement

Protection	Selection of main protection device in fault loop [RCD, FUSE]*
Fuse type	Selection of fuse type [---,BS88, BS3036, BS1361, BS1362, B, C, D] **
Fuse I	Rated current of selected fuse
Fuse T.	Maximum breaking time of selected fuse
Isc_lim	Minimum short circuit current for selected fuse combination.

See Appendix A for reference fuse data.

* Select RCD to prevent trip-out of RCD in RCD protected installation.

** --- Means no fuse selected.

Circuits for measurement of fault loop impedance

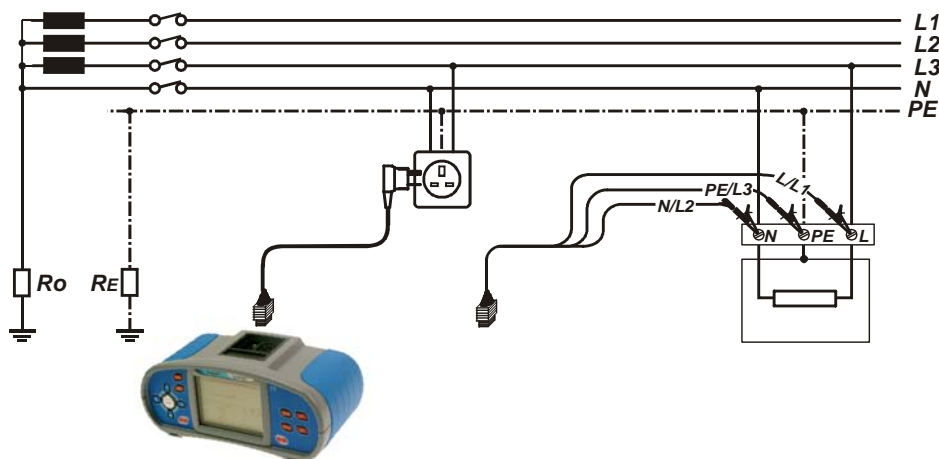

Figure 5.36: Connection of plug cable and universal test cable

Fault loop impedance measurement procedure

- ❑ Select the **Z-LOOP** function.
- ❑ Select test **parameters** (optional).
- ❑ Select measuring **mode** (optional).
- ❑ **Connect** test cable to the EurotestAT.
- ❑ **Connect** test leads to the tested object (see figure 5.36).
- ❑ Press the **TEST** key.
- ❑ After the measurement is finished **store** the result (optional).

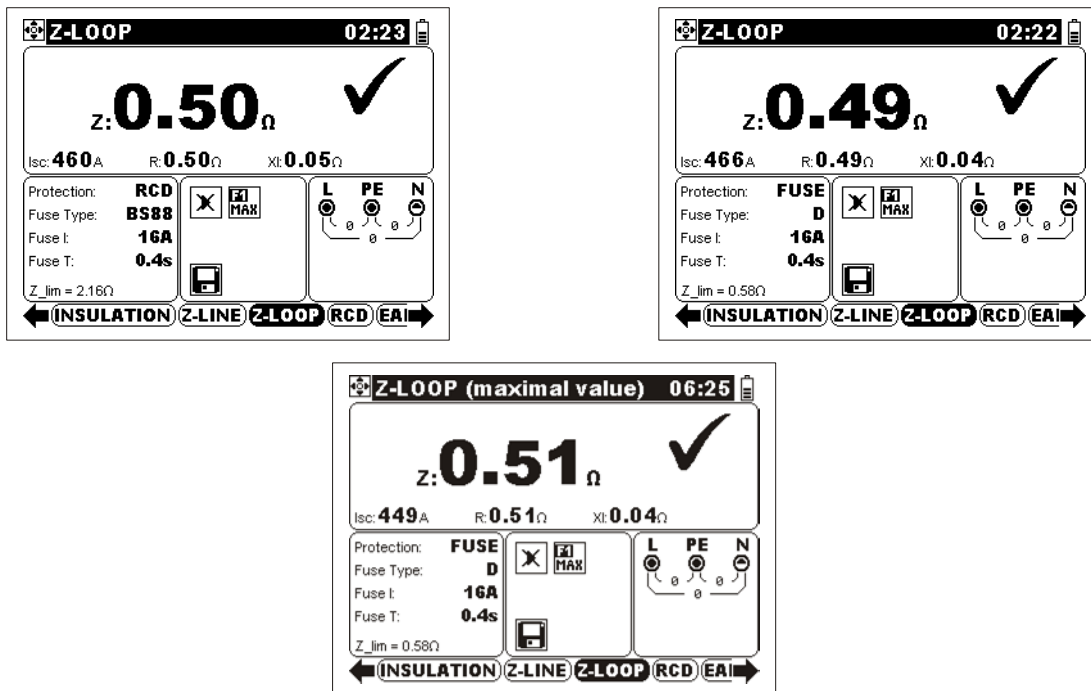

Figure 5.37: Examples of loop impedance measurement result

Displayed results:

- Z Fault loop impedance / maximum fault loop impedance in Zmax function,
- Isc Prospective fault current,
- R Resistive part of loop impedance,
- XI Reactive part of loop impedance.

Maximum limit impedance Z_lim is calculated from required impedance for selected fuse characteristics as follows:

$$Z_lim = Z_{fuse} \times k_{sc}$$

where:

- Un Nominal U_{L-PE} voltage (see table below),
- ksc Z factor (see chapter 4.4.2).

U _n	Input voltage (L-PE)
110 V	(93 V ≤ U _{L-PE} < 134 V)
230 V	(185 V ≤ U _{L-PE} ≤ 266 V)

Notes:

- ❑ High fluctuations of mains voltage influence the measurement results. The noise sign  is displayed in the message field in such case. Repeat the measurement.

- Isc is not calculated in case the terminal voltage monitor does not detect voltage state that corresponds to the selected supply system, indication ?.
- This measurement will trip-out RCD in RCD-protected electrical installation if FUSE is selected as breaking device instead of RCD.

5.8 Line impedance / prospective short-circuit current and Voltage drop

Line impedance is measured in loop comprising of mains voltage source and line wiring. It is covered by the requirements of the EN 61557-3 standard.

The Voltage drop sub-function is intended to check that a voltage in the installation stays above acceptable levels if the highest current is flowing in the circuit. The highest current is defined as the nominal current of the circuit's fuse. The limit values are described in the standard EN 60364-5-52.

Sub-functions:

- Z-LINE – Line impedance measurement according to EN 61557-3,
- ΔU – Voltage drop measurement.

See 4.2 *Single test* for keys functionality.

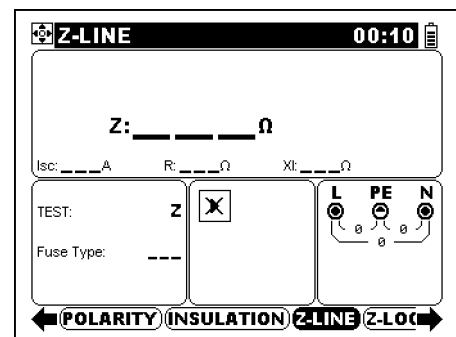

Figure 5.38: Line impedance

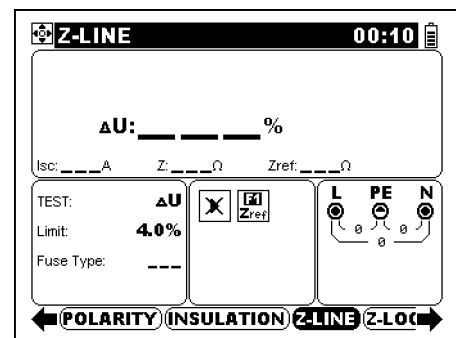

Figure 5.39: Voltage drop

Test parameters for line impedance measurement

TEST	Selection of sub-function [Z, ΔU]
FUSE Type	Selection of fuse type [---, BS88, BS3036, BS1361, BS1362, B, C, D] *
FUSE I	Rated current of selected fuse
FUSE T	Maximum breaking time of selected fuse
Isc_lim	Minimum short circuit current for selected fuse combination.

See Appendix A for reference fuse data.

*--- Means no fuse selected

Additional test parameters for voltage drop measurement

Limit	Maximum voltage drop [3.0 % ÷ 9.0 %].
-------	---------------------------------------

5.8.1 Line impedance and prospective short circuit current

Circuit for measurement of line impedance

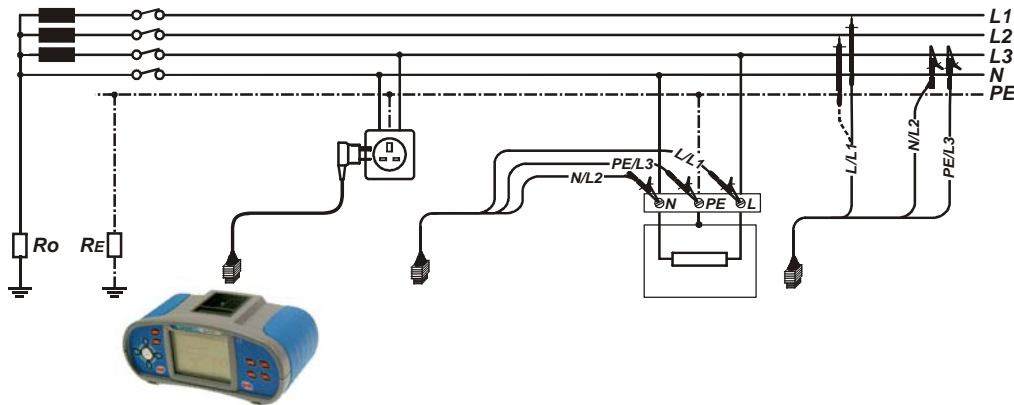
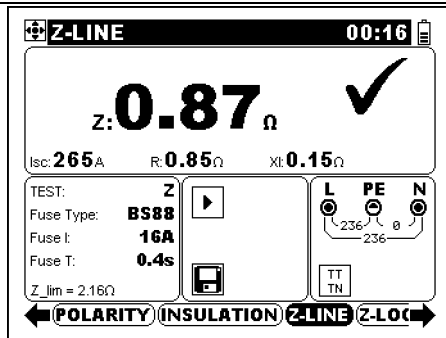

Figure 5.40: Line-Neutral or Line-Line impedance measurement – connection of plug cable and universal test cable

Line impedance measurement procedure

- ❑ Select the **Z-LINE** function.
- ❑ Select the **Z** sub-function.
- ❑ Select test **parameters** (optional).
- ❑ **Connect** test cable to the instrument.
- ❑ **Connect** test leads to the tested object (see figure 5.40).
- ❑ Press the **TEST** key.
- ❑ After the measurement is finished **store** the result (optional).



Line to neutral

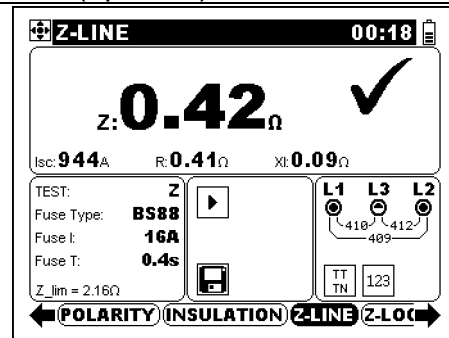

Line to line

Figure 5.41: Examples of line impedance measurement result

Displayed results:

- ZLine impedance,
- IscProspective short-circuit current,
- RResistive part of line impedance,
- XLReactive part of line impedance.

Maximum limit impedance Z_{lim} is calculated from required impedance for selected fuse characteristics as follows:

$$Z_{lim} = Z_{fuse} \times k_{sc}$$



where:

U_n Nominal L-N or L1-L2 voltage (see table below),

kscZ factor (see chapter 4.4.2).

U_n	Input voltage range (L-N or L1-L2)
110 V	$(93 \text{ V} \leq U_{L-N} < 134 \text{ V})$
230 V	$(185 \text{ V} \leq U_{L-N} \leq 266 \text{ V})$
400 V	$(321 \text{ V} < U_{L-L} \leq 485 \text{ V})$

Notes:

- ❑ High fluctuations of mains voltage influence the measurement results. The noise sign  is displayed in the message field in this case. Repeat the measurement.
- ❑ Isc is not calculated in case the terminal voltage monitor does not detect voltage state that corresponds to the selected supply system, indication .

5.8.2 Voltage drop

The voltage drop is calculated based on the difference of line impedance at connection points (sockets) and the line impedance at the reference point (usually the impedance at the switchboard).

Circuits for voltage drop measurement

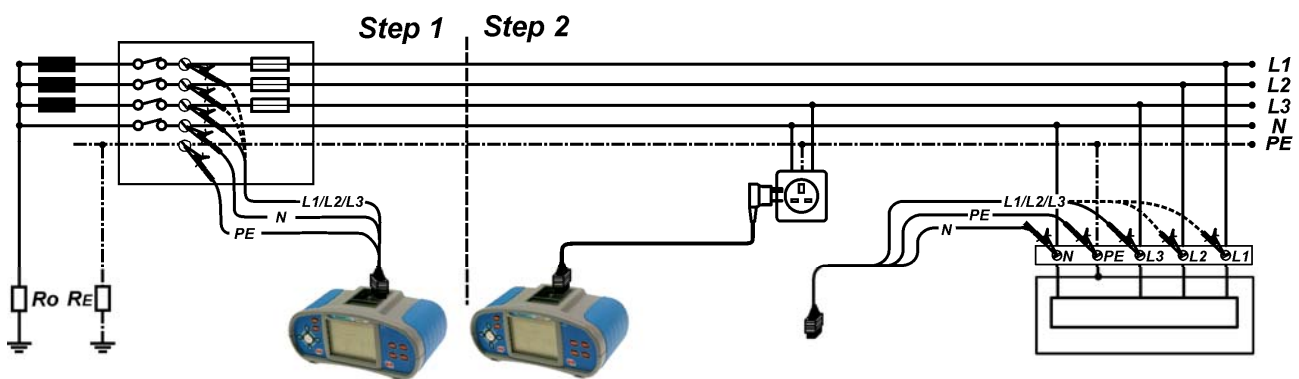

Figure 5.42: Line-Neutral or Line-Line voltage drop measurement – connection of plug cable and 3-wire test lead

Voltage drop measurement procedure

Step 1: Measuring the impedance Z_{ref} at electrical installation origin

- ❑ Select the **Z-LINE** function.
- ❑ Select the **ΔU** sub-function.
- ❑ Select test **parameters** (optional).
- ❑ **Connect** test cable to the instrument.
- ❑ **Connect** the test leads to the origin of electrical installation (see figure 5.42).
- ❑ Press the **F1** key to perform the measurement of Z_{ref} .

Step 2: Measuring the voltage drop

- ❑ Keep the **ΔU** sub-function selected.
- ❑ Select test **parameters** (Fuse type must be selected).
- ❑ **Connect** test cable or plug cable to the instrument.
- ❑ **Connect** the test leads to the tested points (see figure 5.25).
- ❑ Press the **TEST** key to perform the measurement.
- ❑ After the measurement is finished **Store** the result (optional).

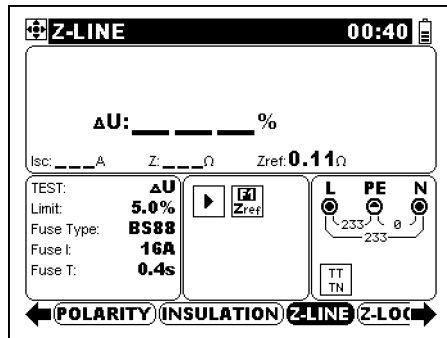

Step 1 - Zref

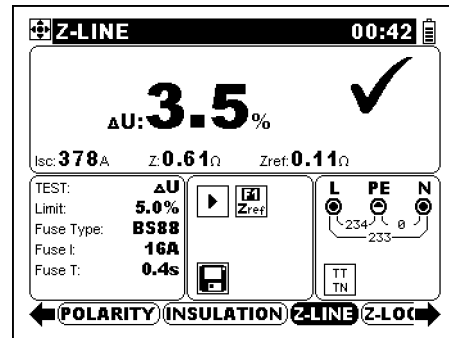

Step 2 - Voltage drop

Figure 5.43: Examples of voltage drop measurement result

Displayed results:

- ΔU Voltage drop,
- I_{SC} Prospective short-circuit current,
- Z Line impedance at measured point,
- Z_{ref} Reference impedance

Voltage drop is calculated as follows:

$$\Delta U [\%] = \frac{(Z - Z_{REF}) \cdot I_N}{U_N} \cdot 100$$

where:

- ΔU calculated voltage drop
- Z impedance at test point
- Z_{REF} impedance at reference point
- I_N rated current of selected fuse
- U_N nominal voltage (see table below)

U _n	Input voltage range (L-N or L1-L2)
110 V	(93 V ≤ U _{L-N} < 134 V)
230 V	(185 V ≤ U _{L-N} ≤ 266 V)
400 V	(321 V < U _{L-L} ≤ 485 V)

Note:

- If the reference impedance is not set the value of Zref is considered as 0.00 Ω.
- The Zref is cleared (set to 0.00 Ω) if pressing F1 key while instrument is not connected to a voltage source.
- I_{SC} is calculated as described in chapter 5.5.1 Line impedance and prospective short circuit current.
- If the measured voltage is outside the ranges described in the table above the ΔU result will not be calculated.
- High fluctuations of mains voltage can influence the measurement results (the noise sign is displayed in the message field). In this case it is recommended to repeat few measurements to check if the readings are stable.

5.9 Voltage, frequency and phase sequence

Voltage and frequency measurement is always active in the terminal voltage monitor. In the special **voltage** menu the measured voltage, frequency and information about detected three-phase connection can be stored. Phase sequence measurement conforms to the EN 61557-7 standard.

See 4.2 *Single test* for keys functionality

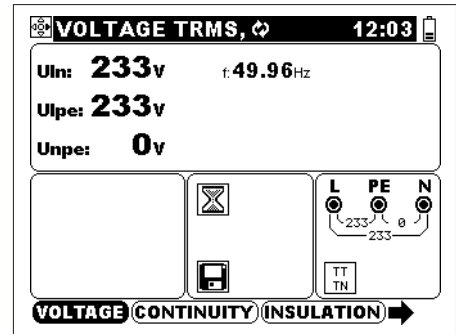

Figure 5.44: Voltage in single phase system

Test parameters for voltage measurement

There are no parameters.

Circuits for voltage measurement

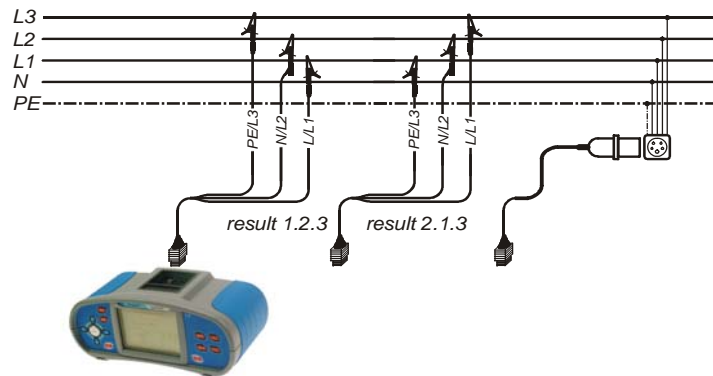

Figure 5.45: Connection of universal test cable and optional adapter in three-phase system

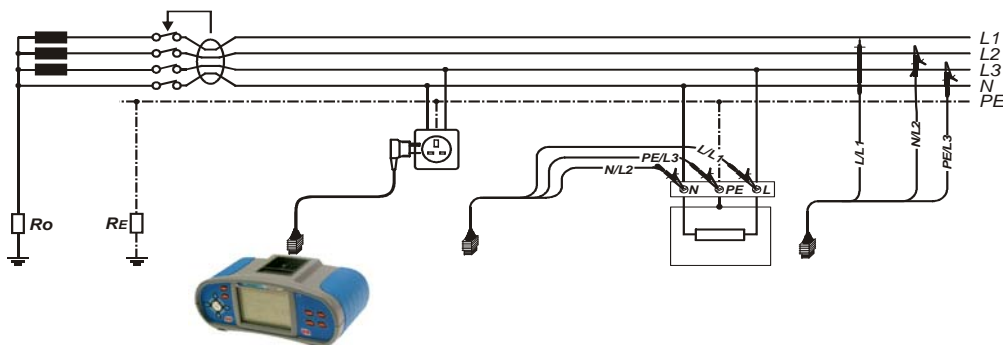

Figure 5.46: Connection of plug cable and universal test cable in single-phase system

Voltage measurement procedure

- ❑ Select the **VOLTAGE** function.
- ❑ **Connect** test cable to the instrument.
- ❑ **Connect** test leads to the tested object (see figures 5.45 and 5.46).
- ❑ **Store** current measurement result (optional).

Measurement runs immediately after selection of **VOLTAGE** function.

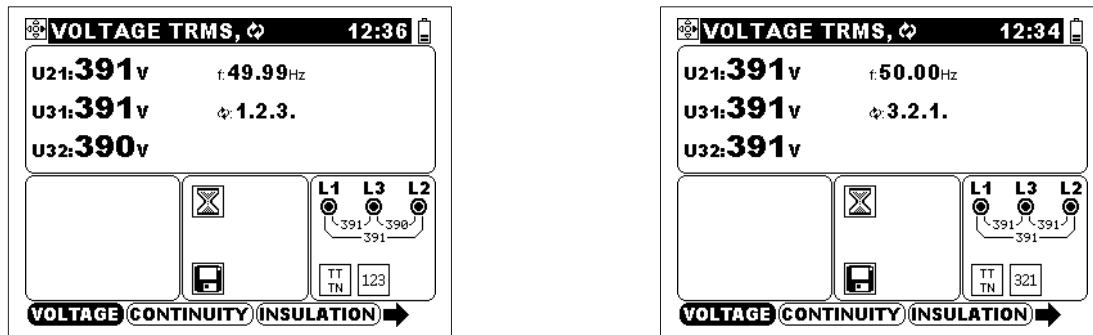

Figure 5.47: Examples of voltage measurement in three-phase system

Displayed results for **single phase** system:

Uln Voltage between phase and neutral conductors,
 Ulpe Voltage between phase and protective conductors,
 Unpe Voltage between neutral and protective conductors,
 f frequency.

Displayed results for **three-phase** system:

U12 Voltage between phases L1 and L2,
 U13 Voltage between phases L1 and L3,
 U23 Voltage between phases L2 and L3,
 1.2.3 Correct connection – CW rotation sequence,
 3.2.1 Invalid connection – CCW rotation sequence,
 f frequency.

5.10 Resistance to earth

Resistance to earth is important for protection against electric shock. This function is intended for verification of earthing of house installation and other earthings, e.g. earthing for lightning. The measurement conforms to the EN 61557-6 standard. The following resistance to earth sub-functions are available:

- Standard 3-wire, for standard resistance to earth measurements.
- Specific earth resistance by using optional external adapter.

See 4.2 Single test for keys functionality.

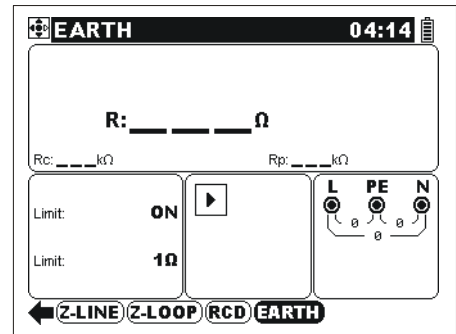

Figure 5.48: Resistance to earth

Parameters for earth resistance measurement

TEST	Test configuration [3-wire, ρ]
Limit	Maximum resistance [OFF, 1 Ω ÷ 5 kΩ]
If ρ selected:	
Distance	Distance between probes [0.1 m ÷ 30.0 m] or [1 ft ÷ 100 ft]

Circuits for measuring resistance to earth

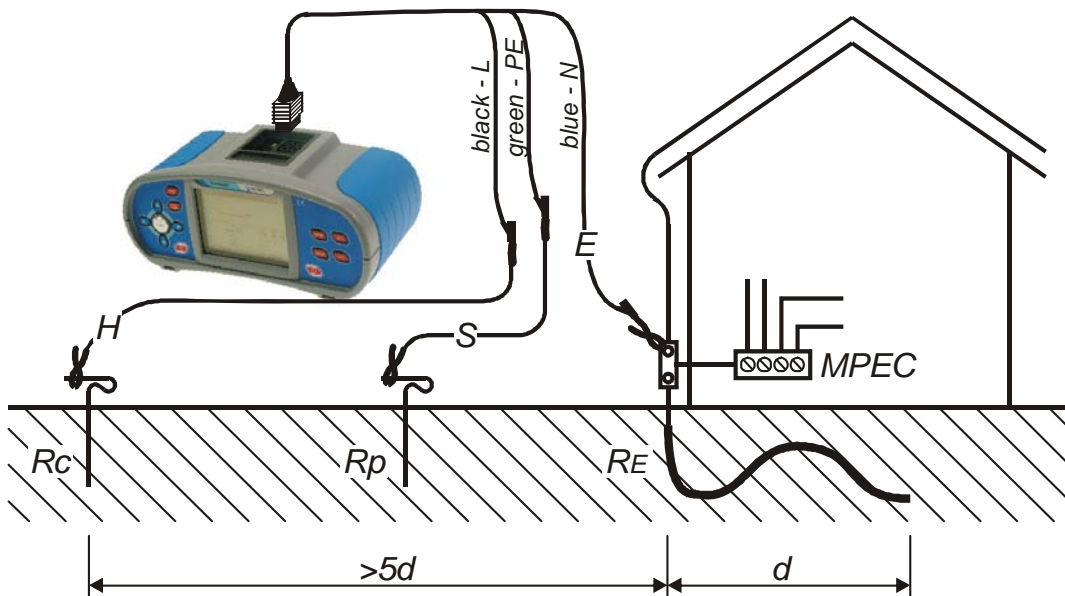

Figure 5.49: Resistance to earth measurement – PE grounding

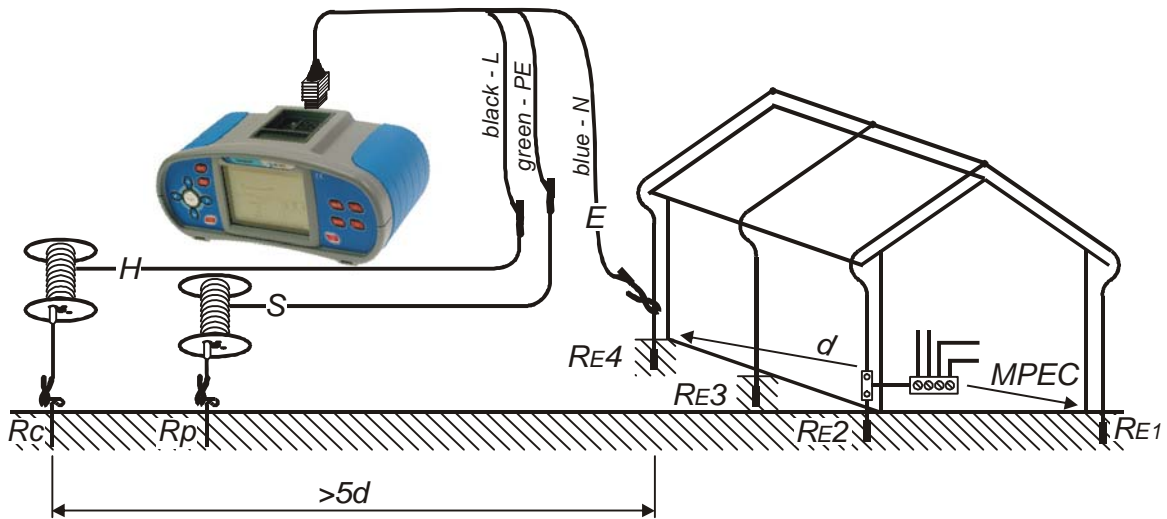

Figure 5.50: Resistance to earth measurement – lightning protection

Resistance to earth measurement procedure

- ❑ Select the **EARTH** function.
- ❑ Enable and set **limit** (optional).
- ❑ **Connect** test cable to the instrument.
- ❑ **Disconnect** tested object from mains supply.
- ❑ **Connect** test leads to the tested object (see figures 5.49 and 5.50).
- ❑ Press the **TEST** key.
- ❑ After the measurement is finished **store** the result (optional).

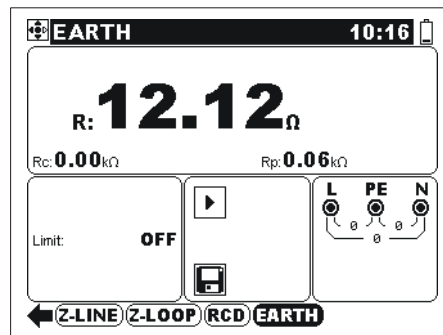

Figure 5.51: Example of resistance to earth measurement result

Displayed results for earth resistance measurement:

- R.....Earth resistance,
- Rc.....Resistance of S probe,
- Rp.....Resistance of H probe.

5.10.1 Specific earth resistance measurement

The measurement is intended for measuring specific earth resistance by using special adapter A1199.

Circuit for specific earth resistance measurement

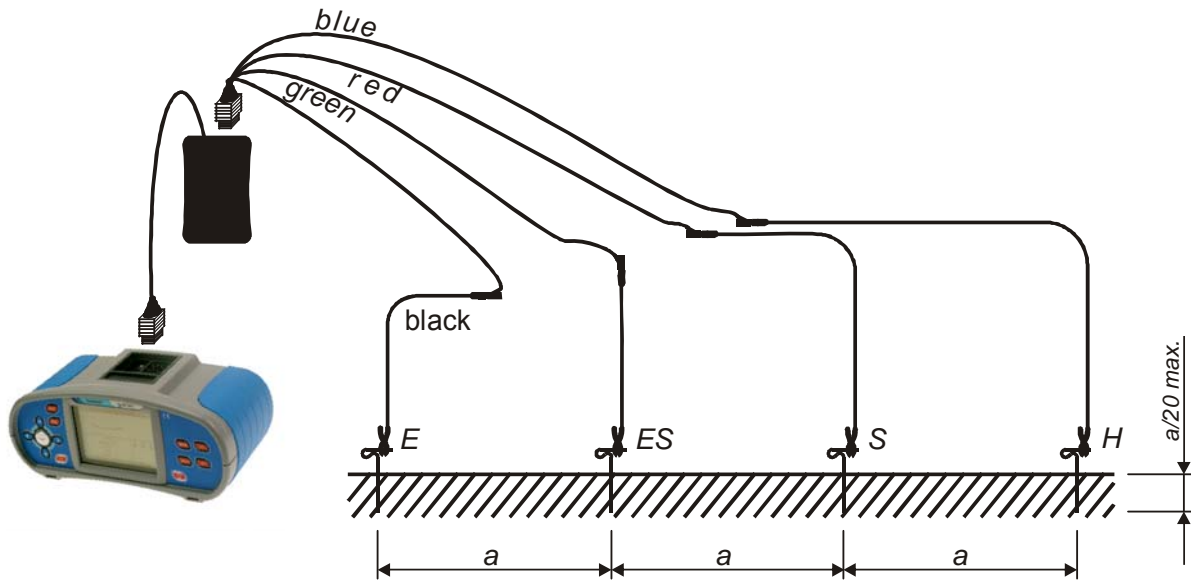

Figure 5.52: Specific earth resistance measurement with ρ -adapter

Specific earth resistance measurement procedure

- ❑ Select the **EARTH** function.
- ❑ Connect **ρ -adapter** to the instrument.
- ❑ Select ρ measurement.
- ❑ Select distance **unit** (optional).
- ❑ Set **distance** (optional).
- ❑ Connect test leads of **ρ -adapter** to tested object (see figure 5.52)
- ❑ Press the **TEST** key.
- ❑ After the measurement is finished, **store** the result (optional).

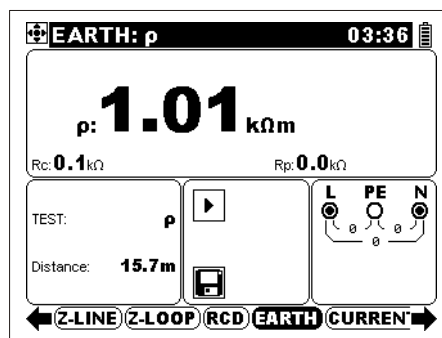

Figure 5.53: Example of specific earth resistance measurement result

Displayed results for earth resistance measurement:

- ρ Specific earth resistance.
- Rc.....Resistance of S probe,
- ρ Rp Resistance of H probe.

Note:

- ❑ Distance units can be selected in Miscellaneous/Initial settings/Other settings menu, see 4.4.5.

5.11 2 Ω line/loop impedance

The measurement extends application range of the instrument and is performed with Impedance adapter A1143 connected to the instrument via RS 232 interface. It is automatically recognized in Z-LINE and Z-LOOP functions. With this adapter, low impedances up to 1999 m Ω can be measured. The measurement is covered by requirements of the EN 61557-3 standard.

See chapter 4.2 *Single test* for functionality of keys.

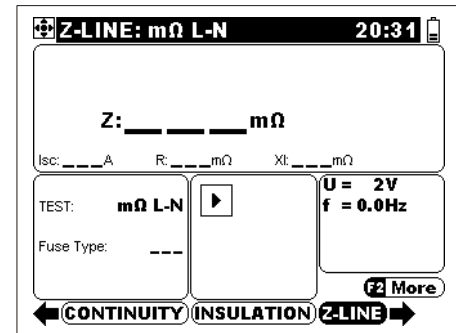

Figure 5.54: Impedance adapter connected

Test parameters for 2 Ω line/loop impedance measurement

Function Z-LINE	
Test	Impedance function [m Ω L-N, m Ω L-L]
Functions Z-LINE and Z-LOOP	
FUSE type	Selection of fuse type [---, BS88, BS3036, BS1361, BS1362, B, C, D] *
FUSE I	Rated current of selected fuse
FUSE T	Maximum breaking time of selected fuse
Isc_lim	Minimum short circuit current for selected fuse combination.

See Appendix A for reference fuse data.

*--- Means no fuse selected

Additional key:

F2	Toggles between result screens.
-----------	---------------------------------

Test setup for 2 Ω line/loop impedance measurement



Figure 5.55: Connection of impedance adapter to the instrument

2 Ω line/loop impedance measuring procedure

- ❑ **Connect** Impedance adapter to the instrument (see figure 5.55).
- ❑ Select the functions **Z-LINE** or **Z-LOOP**.
- ❑ Enable and set **limit** value (optional).
- ❑ Power **ON** the Impedance adapter (ON/OFF key, green LED lits).
- ❑ **Connect** Impedance adapter to tested installation.
- ❑ Press the **TEST** key for measurement.
- ❑ **Store** the result (optional).

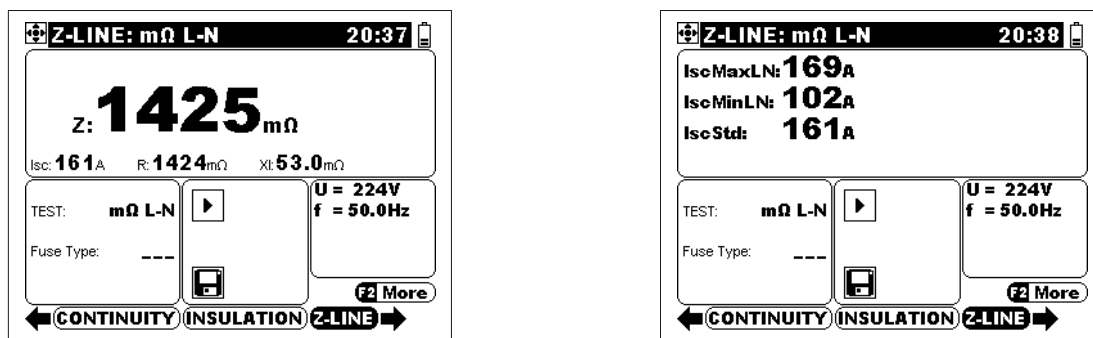

Figure 5.56: Example of 2 Ω line/loop measurement results

Displayed results:

Z Line / loop impedance,
 Isc Prospective short-circuit current,
 R Resistive part of line impedance,
 XI Reactive part of line impedance.

The following parameters are displayed in sub-screen for single-phase line impedance measurement:

IscMaxL-N Maximum prospective short-circuit current.
 IscMinL-N Minimum prospective short-circuit current.
 IscStd Standard prospective short-circuit current.

When testing phase-to-phase line impedance the following parameters are displayed in sub-screen:

IscMax3Ph..... Maximum three-phase prospective short-circuit current.
IscMin3Ph..... Minimum three-phase prospective short-circuit current.
IscMax2Ph..... Maximum two-phase prospective short-circuit current.
IscMin2Ph..... Minimum two-phase prospective short-circuit current.
IscStd Standard prospective short-circuit current.

The following parameters are displayed in sub-screen for loop impedance measurement:

IscMaxL-Pe Maximum prospective fault current.
IscMinL-Pe Minimum prospective fault current.
IscStd Standard prospective fault current.
Ub..... Contact voltage at maximum prospective fault current (Contact voltage is measured against probe S).

Notes:

- For application and technical data of the Impedance adapter A1143, see its user manual 20750859.
- High fluctuations of mains voltage can influence the measurement results.
- Check adapter indications in case the abort  symbol appears after the start of measurement.

5.12 PE test terminal

It can happen that a dangerous voltage is applied to the PE wire or other accessible metal parts. This is a very dangerous situation since the PE wire and MPEs are considered to be earthed. A common reason for this fault is incorrect wiring (see examples below).

When touching the **TEST** key in all functions that require mains supply the user automatically performs this test.

Examples for application of PE test terminal

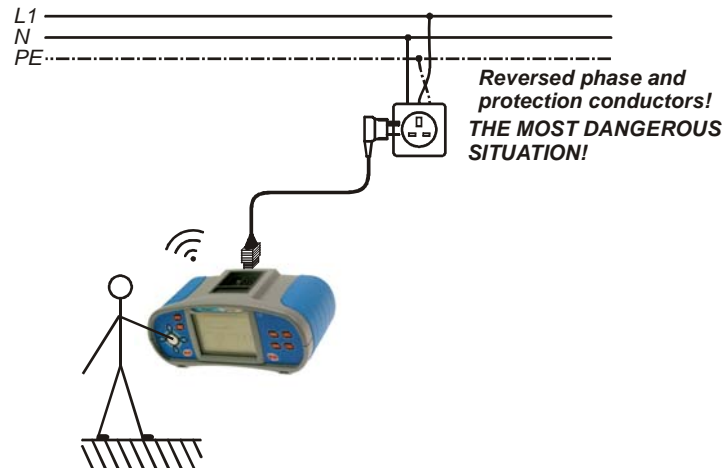

Figure 5.57: Reversed L and PE conductors (application of plug cable)

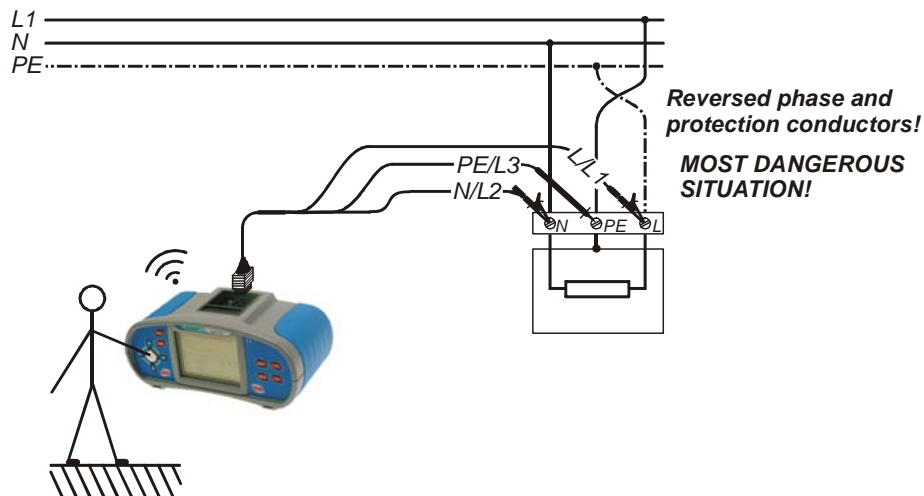

Figure 5.58: Reversed L and PE conductors (application of universal test cable)

PE terminal test procedure

- ❑ **Connect** test cable to the instrument.
- ❑ **Connect** test leads to the tested object (see figures 5.57 and 5.58).
- ❑ Touch PE test probe (the **TEST** key) for at least one second.
- ❑ If PE terminal is connected to phase voltage the warning message is displayed, instrument buzzer is activated, and further measurements are disabled in Z-LOOP and RCD functions.

Warning:

- ❑ If line voltage is detected on the tested PE terminal, immediately stop all measurements, find and remove the fault!

Notes:

- In main and miscellaneous menus the PE terminal is not tested.
- PE test terminal does not operate in case the operator's body is completely insulated from floor or walls!

5.13 Locator

This function is intended for tracing mains installation, like:

- Tracing lines,
- Finding shorts, breaks in lines,
- Detecting fuses.

The instrument generates test signals that can be traced with the handheld tracer receiver R10K. See *Locator appendix* for additional information.

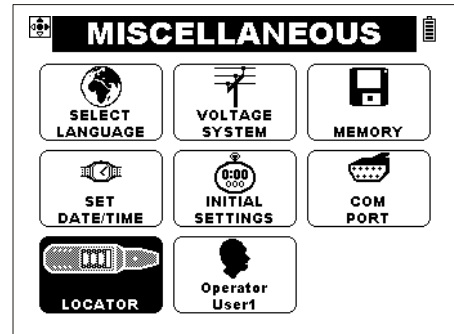

Figure 5.59: Locator entry point

Parameters for locator

There are no parameters.

Typical applications for tracing electrical installation

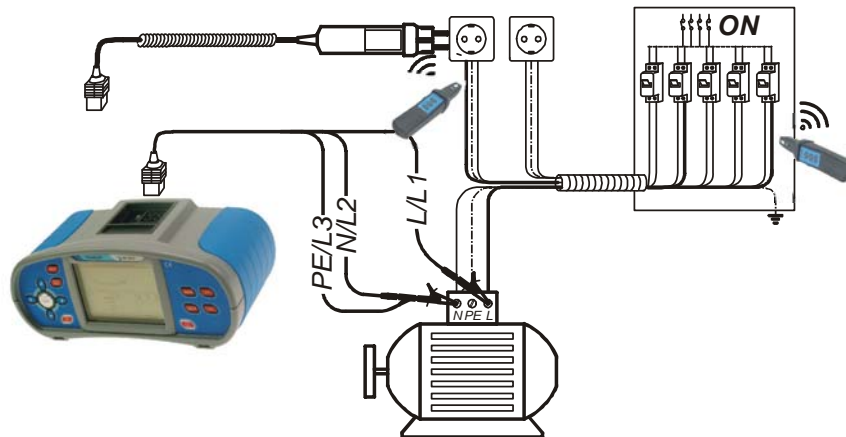

Figure 5.60: Tracing wires under walls and in cabinets

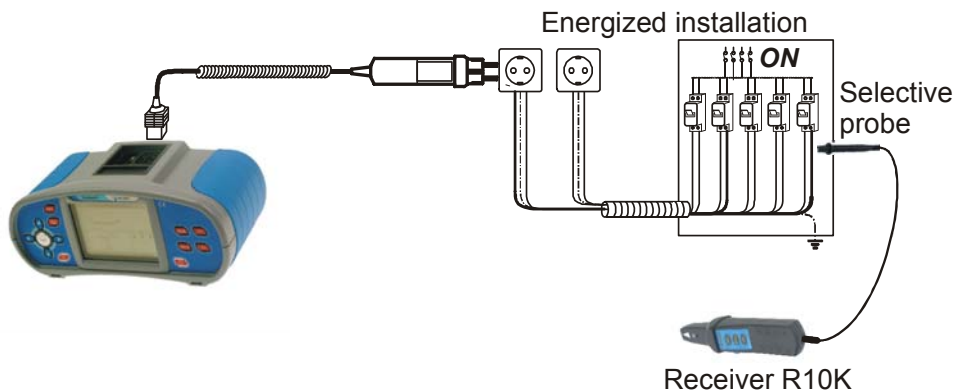

Figure 5.61: Locating individual fuses

Line tracing procedure

- ❑ Select the **LOCATOR** function in MISC menu.
- ❑ **Connect** test cable to the instrument.
- ❑ **Connect** test leads to the tested object (see *figures 5.60 and 5.61*).
- ❑ Press the **TEST** key.
- ❑ Trace lines with receiver (in IND mode) or receiver plus its optional accessory.
- ❑ After tracing is finished press the **ESC** key to stop generating test signal.

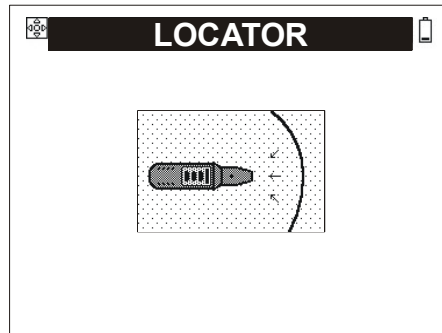

Figure 5.62: Locator active

5.14 Varistor test

This test is performed to verify overvoltage protection devices. Typical devices are:

- Metal oxide varistors,
- Gas arresters,
- Semiconductor transient voltage suppressors.

See chapter 4.2 *Single test* for functionality of keys.

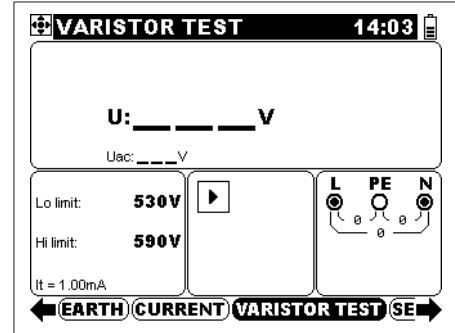

Figure 5.63: Varistor test menu

Test parameters for varistor test

Lo limit	Low limit DC threshold voltage [50 V ÷ 1000 V]
Hi limit	High limit DC threshold voltage [50 V ÷ 1000 V]
It = 1.00 mA	Threshold current

Test circuit for varistor test

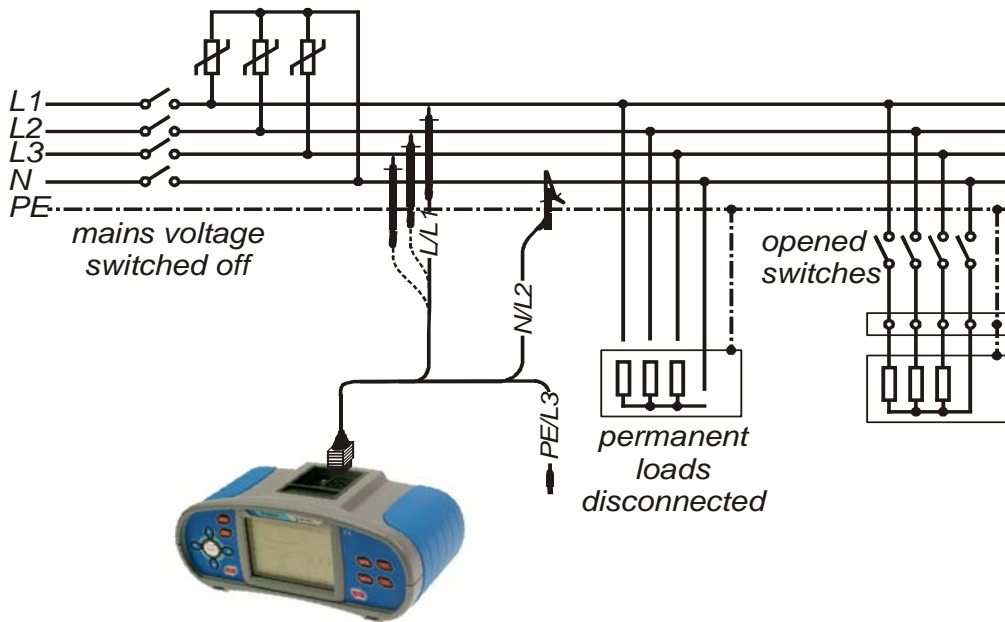

Figure 5.64: Connection of universal test cable for varistor test

Varistor test procedure

- ❑ Select the **VARISTOR TEST** function.
- ❑ Set test **parameters**.
- ❑ Disconnect mains supply and consumers from tested overvoltage device.
- ❑ **Connect** test cable to the instrument and tested item (see figure 5.64).
- ❑ Press the **TEST** key for measurement.
- ❑ After the measurement is finished wait until tested item is discharged.
- ❑ **Store** the result (optional).

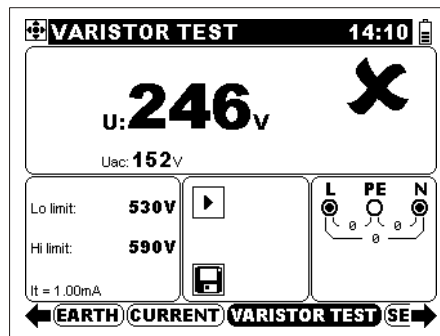

Figure 5.65: Example of varistor test result

Displayed results:

UMeasured threshold voltage at I_t (1 mA).

UacRated AC voltage.

Uac is calculated from U according to: $U_{ac} = U/1.6$.

6 Data handling

6.1 Memory organization

The following data can be stored in instrument memory:

- Auto sequence name, sequence, and function parameters,
- Auto sequence and single test results with belonging parameters,
- Installation structure with belonging data.

Stored data can be organized according to the installation structure of the tested object. Measured results can be stored into corresponding location of the structure.

6.2 Installation data structure

This functionality helps to organize operation with data in a simple and effective manner. The memory organization can be customized according to the actual structure of the tested electrical installation.

Main benefits are:

- Test results can be organized and grouped in a structured manner that equals the structure of the tested electrical installation. If a test plan for verification of electrical installation is prepared it is possible to organize the data structure according to it. Each tested location place like room, floor, installation node, switchgear, etc. can be reflected as its own location in memory.
- Simple browsing through structure and results.
- Test reports can be created with no or little modifications after downloading results to a PC.
- Test procedures can be prepared in advance on the PC and sent to the instrument.
- A new installation structure can be built on the instrument
- An existing structure can be upgraded on the instrument.
- A name can be assigned to each location.

The data structure can be accessed and updated in each of the three main memory menus (store, recall, clear memory), but also through tree structure view.

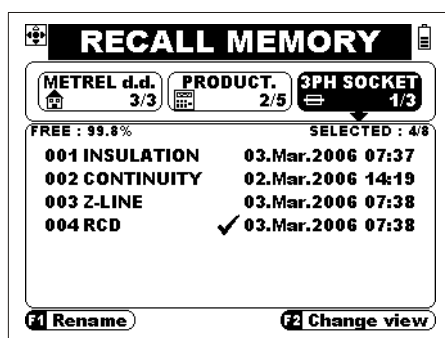

Basic view

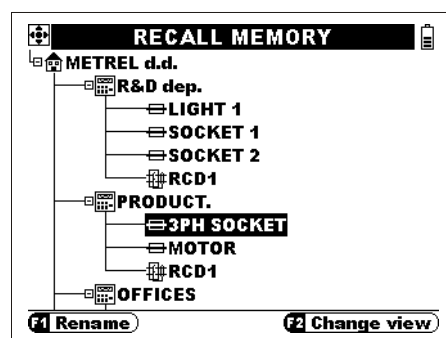

Tree structure view

Figure 6.1: Example of data structure fields

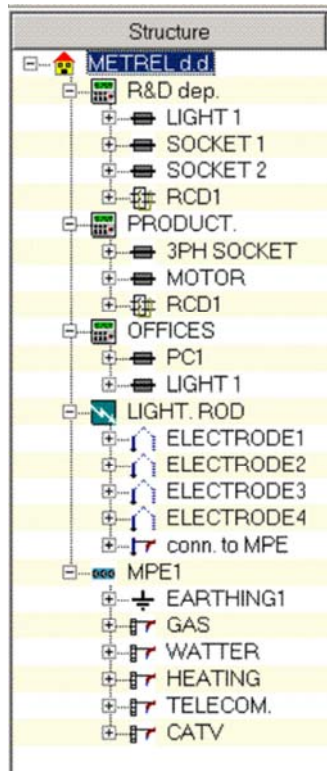

Figure 6.2: Installation structure example as presented on PC

Legend:

RECALL MEMORY	Memory operation menu
	Installation data structure field
	Root level in the structure: <ul style="list-style-type: none"> □ METREL d.d.: 1st level location name. □ 1/1: No. of selected / available locations on this level.
	Sub-level (level 2) in the structure: <ul style="list-style-type: none"> □ PRODUCT.: sub-location name. □ 2/5: No. of selected / available locations on this level.
	Sub-level (level 3) in the structure: <ul style="list-style-type: none"> □ 3PH SOCKET: location name. □ 1/3: No. of selected / available locations on this level.
	Results field – stored results in the selected location.
	Arrows point to existing non-displayed structure locations.
FREE : 98.9%	Available memory information.
SELECTED : 4/43	No. of stored test results in selected location / No. of all stored test results (in complete structure).
	Option for opening the structure tree view.
	Options for modification of the structure (see chapter 6.6).

Note:

- Only three locations in the installation data structure field (placed horizontally) can be displayed at the same time in the basic view.

Keys:

↓ / ↑ / ← / →	Select the existing location.
↓	Pressed for 2 s opens dialog box for adding a new location.
F2	Enters installation structure tree screen.
F1	Renames the current location.
HELP	Enters installation structure tree screen.
ESC	Back to the last operation mode of the instrument.

Note:

- The tree structure is limited to 2000 locations with 10 levels in depth, see figure 6.3.

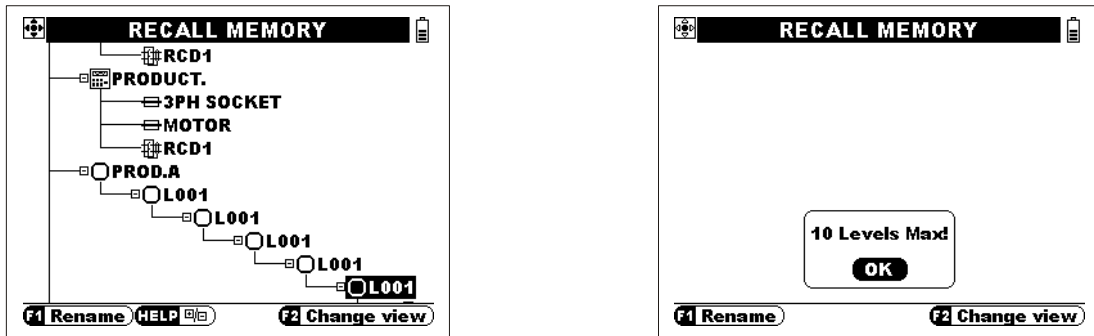

Figure 6.3: Sub-levels depth definition

Figure 6.4 shows how individual structure elements are displayed on the instrument. The outlook is the same for all three memory menus.

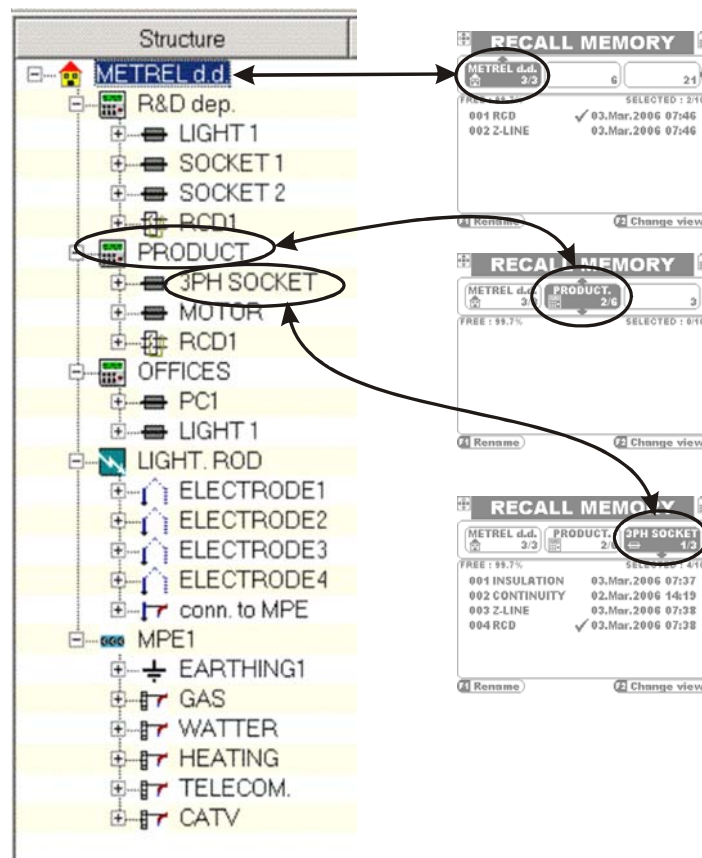

Figure 6.4: Data structure elements

6.3 Storing test results

After the completion of a single test or auto sequence the results and parameters are ready for storing (📄 icon is displayed in the information field). Press the **MEM** key to store the results.

See *chapter 6.2* for definitions of displayed fields.

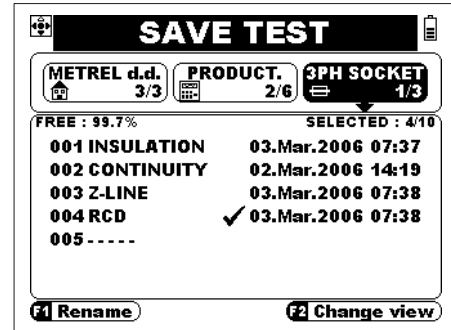

Figure 6.5: Save test menu

Keys in save test menu - installation data structure field:

← / → / ↓ / ↑	Short press - select the location in structure of installation data field. Pressed for a few seconds in some cases - add a new location in the structure, see 6.6.1.
MEM	Saves test results to the last position in selected location and returns to the measuring menu.
TAB	Toggles between results and structure data fields, see 6.3.1.
ESC	Exits save test menu.
F1	Edits name of selected location (see 4.3.4).
F2	Enters installation structure tree view to select appropriate location.

Notes:

- ❑ Press the **MEM** key twice to quickly store the results to pre-selected location.
- ❑ By default it is offered to append the result to the existing results in the selected location.

6.3.1 Saving results specialties

It is possible to overwrite existing result when storing new result.

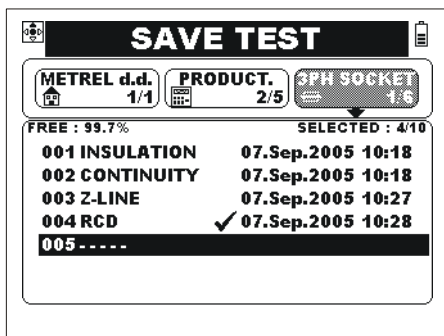

Appending new result

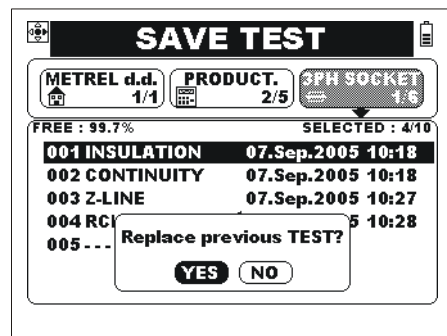

Overwriting requires confirmation

Figure 6.6: Saving in result field

Keys in save test menu - results field:



↓ / ↑	Select stored test result.
TEST	Saves test result into selected line (confirmation is needed to overwrite an existing result).
ESC	Back to store test menu - installation data structure field.

Keys with open dialog:

← / →	Select YES / NO.
TEST	Confirms selected option.
ESC	Cancels without changes.

For information about storing into a new non-existent location see 6.6.1.

6.4 Recalling test results and parameters

Press the **MEM** key in single or auto sequence menu when there is no result available for storing or select  in **MISC**  menu.

See 6.2 for definitions of displayed fields.

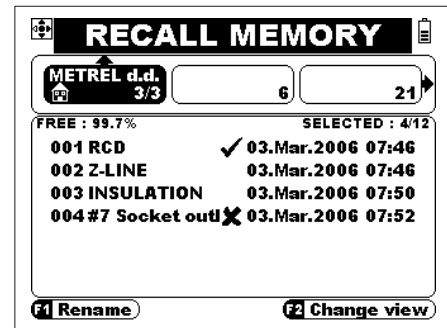

Figure 6.7: Main recall menu

Keys in main recall memory menu:

← / → / ↓ / ↑	Short press - select the location in structure of installation data field. Pressed for a few seconds in some cases - add a new location in the structure, see 6.6.1.
TAB	Toggles between results and structure data field.
ESC	Exits to the last state of the instrument.
F1	Edits name of selected location (for editing see 4.3.4).
F2	Enters installation structure tree view to select appropriate location.

6.4.1 Recalling result

Result field has to be selected.

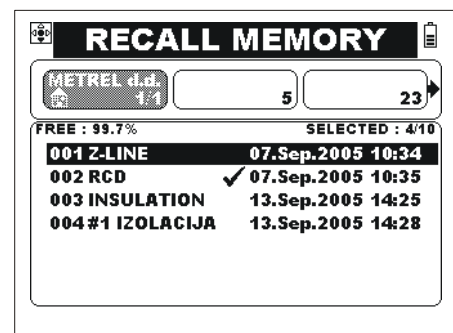

Figure 6.8: Recall data menu

Keys in results field:

↓ / ↑	Select the stored data.
TEST	Opens selected stored item.
TAB, ESC	Back to recall memory main menu.

Key:

ESC	Back to recall memory main menu.
------------	----------------------------------

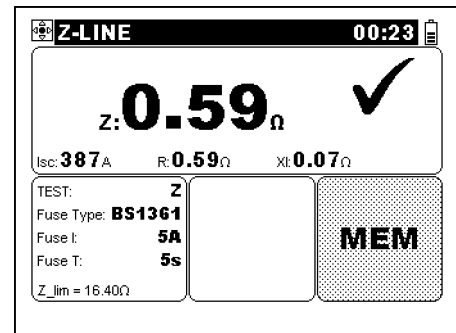

Figure 6.9: Stored single test example

Keys:

↓ / ↑	Select stored data.
TEST	Opens function result.
ESC	Back to recall memory main menu.

Key in open function result:

ESC	Back to observed auto sequence.
------------	---------------------------------

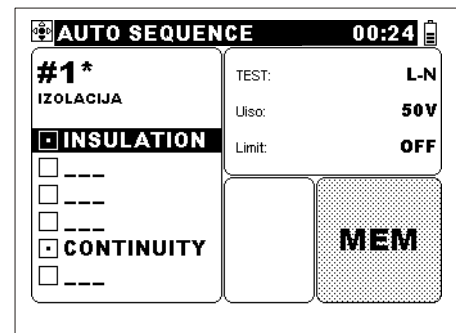





Figure 6.10: Auto sequence stored example

6.5 Clearing saved data

From main menu select miscellaneous menu and enter  option (see 4.4.3).

In  select  option for erasing complete test results memory.

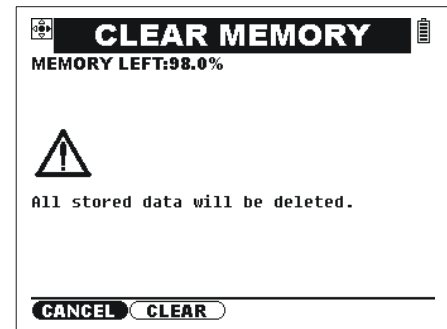



Figure 6.11: Clear memory

Keys:

← / →	Select CANCEL / CLEAR.
TEST	Confirms selected option.
ESC	Cancels dialog without changes.

In  select  option to delete particular result or modify installation data structure.

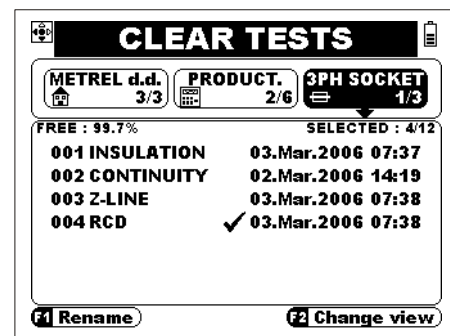

Figure 6.12: Clear test menu

Keys:

↓ / ↑	Select location.
TEST	Opens dialog for clearing in installation data structure.
TAB	Moves focus into result field for selection of surplus result, see 6.5.1.
F2	Enters installation structure tree view to select appropriate location.
F1	Renames current location.
ESC	Back to the last mode of the instrument.

6.5.1 Clearing specialties

In the result field the particular stored test result can be cleared.

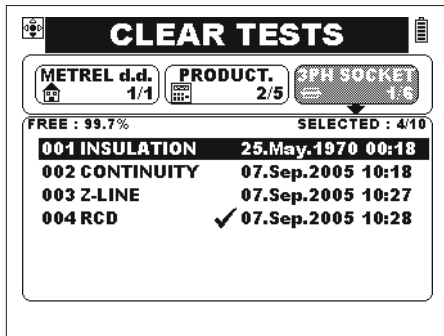

Selection of data for clearing

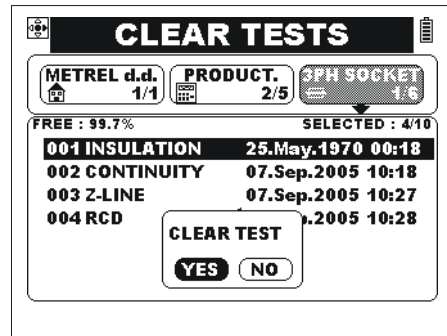

Dialog before clear

Figure 6.13: Clearing particular test

Keys:

↓ / ↑	Select stored test.
TEST	Opens dialog for clearing selected test.
ESC	Back to last mode of the instrument.

Keys in opened dialog:

← / →	Select YES / NO.
TEST	Confirms selected option.
ESC	Cancels without changes.

Legend for clearing in installation data structure:

CURRENT Location	Results in current location.
SUB Locations	Results in sub-locations.
TREE Structure	Remove current location and its sub-locations.

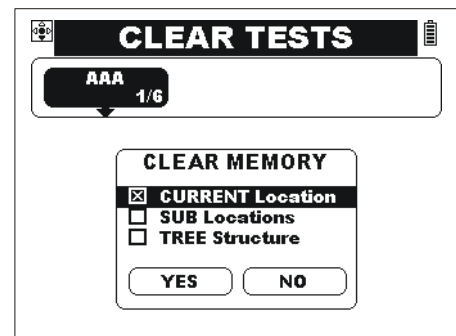

Figure 6.14: Clear in installation data structure menu

Keys:

← / → / ↓ / ↑	Select option.
TEST	Confirms option.
ESC	Cancels dialog without changes.

6.6 Editing installation data structure

Installation data structure when once stored in the instrument can also be modified during use of the instrument. Editing possibilities are:

- Adding new location – see 6.6.1,
- Modifying the name of selected location,
- Clearing location / tree structure, see 6.5.1.

The possibilities are accessible in save, recall and clear (partly) menus.

6.6.1 Adding new locations

Note:

- The structure can be expanded to 10 horizontal levels deep and with maximum 2000 storing locations.

Keys:

← / → / ↓ / ↑	Select the existing location. <i>Pressed for a few seconds in some cases - add a new location in the structure, see 6.6.1.</i>
F2	Enters installation structure tree view to select appropriate location.
F1	Renames the current location.
ESC	Back to the last operation mode of the instrument.
↓ (for 2 seconds)	Opens dialog box for adding new location at the same level. Active only if selected location is the last in the level. Name of the new location: <u>Same name as previous +1.</u>
→ (for 2 seconds)	Opens dialog box for adding new location at the next sublevel. Active only if there are no sublevels at the selected location. Name of the new location: <u>Location</u>

Keys in open dialog box:

← / →	Select YES / NO.
TEST	Confirms selected option.
ESC	Cancels dialog box without changes.

An example for opening a new location and storing a test result into the location is presented below.

Finished test with the results prepared for **saving** is marked with  icon.

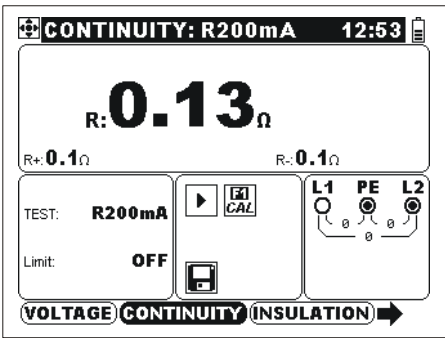
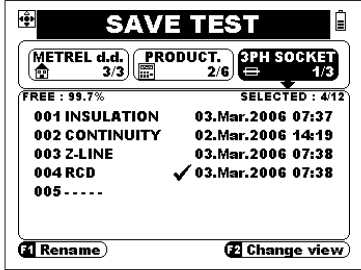
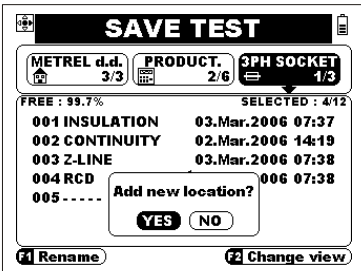

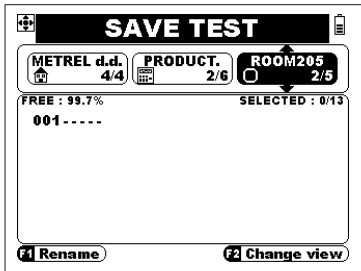
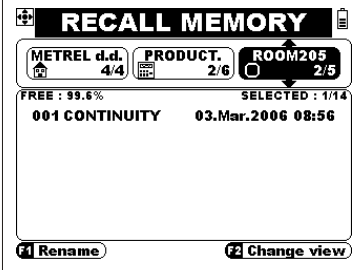

Figure 6.15: Test result prepared for saving

<p>Key: MEM Enters the save test menu.</p>	 <p>Figure 6.16: Save test menu</p>
<p>Keys: F2 Changes structure view. TEST Confirms the new location. F1 Enters name of the location.</p>	 <p>Figure 6.17: Dialog box for new location</p>
<p>Enter name of the location. Key: F2 Confirms the name.</p>	 <p>Figure 6.18: Entering name for the new location</p>
<p>Key: MEM Saves results into the location.</p>	 <p>Figure 6.19: Location prepared</p>
	 <p>Figure 6.20: Stored example</p>

6.7 Communication

Stored results can be transferred to a PC. A special communication program on the PC automatically identifies the instrument and enables data transfer between the instrument and the PC.

There are two communication interfaces available on the instrument: USB or RS 232 (for selection see 4.4.6).

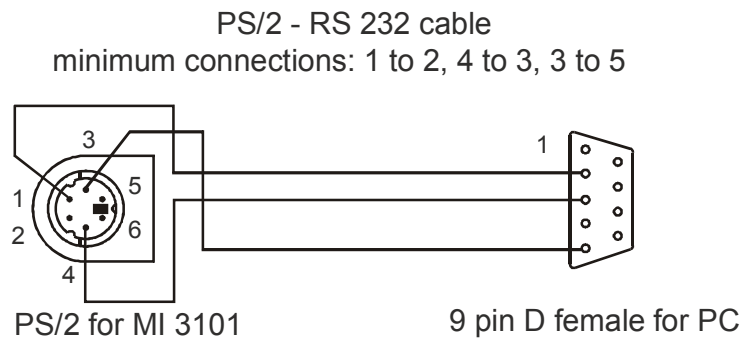



Figure 6.21: Interface connection for data transfer over PC COM port

How to transfer stored data:

- In the MISC:  select appropriate communication interface (USB / RS 232).
RS 232 selected: connect a PC COM port to the instrument PS/2 connector using the PS/2 - RS232 serial communication cable;
USB selected: connect a PC USB port to the instrument USB connector using the USB interface cable.
- Power **on** the PC and the instrument.
- Run** the program *EuroLink*.
- The PC and the instrument automatically recognize each other.
- The program on the PC enables the following possibilities:
Downloading data;
Clearing storage;
Changing and downloading user data;
Preparing a simple report form;
Preparing a file for exporting to a spreadsheet.

The program *EuroLink* is a PC software running on Windows NT, Windows 2000, Windows XP, Windows Vista, Windows 7. Read the file README_EuroLink.txt on CD for instructions about installing and running the program.

Note:

- USB drivers should be installed on PC before using the USB interface. Refer to USB installation instructions available on installation CD.

7 Maintenance

Unauthorized person is not allowed to open the EurotestAT instrument. There are no user replaceable components inside the instrument, except three fuses and batteries under rear cover.

7.1 Replacing fuses

There are three fuses under back cover of the EurotestAT instrument.

- F1
M 0.315 A / 250 V, 20×5 mm
This fuse protects internal circuitry of continuity function if test probes are connected to the mains supply voltage by mistake during measurement.
- F2, F3
F 4 A / 500 V, 32×6.3 mm
General input protection fuses of test terminals L/L1 and N/L2.

Warnings:

-  Disconnect any measuring accessory and power off the instrument before opening battery/fuse compartment cover, hazardous voltage inside!
- Replace blown fuse with original type only, otherwise the instrument may be damaged and/or operator's safety impaired!

Position of fuses can be seen in *Figure 3.4* in chapter 3.3 *Back panel*.

7.2 Cleaning

No special maintenance is required for the housing. To clean the surface of the instrument use a soft cloth slightly moistened with soapy water or alcohol. Then leave the instrument to dry totally before use.

Warnings:

- Do not use liquids based on petrol or hydrocarbons!
- Do not spill cleaning liquid over the instrument!

7.3 Periodic calibration

It is essential that the test instrument is regularly calibrated in order technical specification listed in this manual is guaranteed. We recommend an annual calibration. Only an authorized technical person can do the calibration. Please contact your dealer for further information.

7.4 Service

For repairs under warranty, or at any other time, please contact your distributor.

8 Technical specifications

8.1 Insulation resistance

Insulation L-N, L-PE, N-PE, L1-L2, L1-L3, L2-L3

Insulation resistance (nominal voltages 50 V_{DC}, 100 V_{DC} and 250 V_{DC})

Measuring range according to EN61557 is 0.25 M Ω \div 199.9 M Ω .

Measuring range (M Ω)	Resolution (M Ω)	Accuracy
0.00 \div 19.99	0.01	\pm (5 % of reading + 5 digits)
20.0 \div 99.9	0.1	\pm (10 % of reading)
100.0 \div 199.9		\pm (20 % of reading)

Insulation resistance (nominal voltages 500 V_{DC} and 1000 V_{DC})

Measuring range according to EN61557 is 0.15 M Ω \div 1000 M Ω .

Measuring range (M Ω)	Resolution (M Ω)	Accuracy
0.00 \div 19.99	0.01	\pm (5 % of reading + 3 digits)
20.0 \div 199.9	0.1	\pm (10 % of reading)
200 \div 299	1	
300 \div 1000	1	\pm (20 % of reading)

Insulation ALL and 'L-PE,N-PE', 'L-N,L-PE', ALL 3ph

Insulation resistance (nominal voltages 50 V_{DC}, 100 V_{DC}, 250 V_{DC}, 500 V_{DC}, 1000 V_{DC})

Measuring range according to EN61557 is 0.34 M Ω \div 30.0 M Ω .

Measuring range (M Ω)	Resolution (M Ω)	Accuracy
0.00 \div 19.99	0.01	\pm (10 % of reading + 5 digits)
20.0 \div 30.0	0.1	

Voltage

Measuring range (V)	Resolution (V)	Accuracy
0 \div 1200	1	\pm (3 % of reading + 3 digits)

Nominal voltages 50 V_{DC}, 100 V_{DC}, 250 V_{DC}, 500 V_{DC}, 1000 V_{DC}

Open circuit voltage -0 % / + 20 % of nominal voltage

Measuring current..... min. 1 mA at RN=UN \times 1 k Ω /V

Short circuit current..... max. 0.6 mA

Specified accuracy is valid if universal test cable is used while it is valid up to 100 M Ω if tip commander is used.

Specified accuracy is valid up to 100 M Ω if relative humidity > 85%.

In case the instrument gets moistened the results could be impaired. In such case it is recommended to dry the instrument and accessories for at least 24 hours.

The error in operating conditions could be at most the error for reference conditions (specified above for each function) \pm 5 % of measured value.

The number of possible tests..... > 1200, with a fully charged battery

Auto discharge after test.

8.2 Continuity

8.2.1 Resistance General 200mA, R2, R1+R2

Measuring range according to EN61557 is 0.16 Ω ÷ 1999 Ω .

Measuring range R (Ω)	Resolution (Ω)	Accuracy
0.00 ÷ 19.99	0.01	$\pm(3\%$ of reading + 3 digits)
20.0 ÷ 199.9	0.1	$\pm(5\%$ of reading)
200 ÷ 1999	1	
2000 ÷ 9999	1	Indicator only

Measuring range R+, R- (Ω)	Resolution (Ω)	Accuracy
0.00 ÷ 19.9	0.1	$\pm(5\%$ of reading + 5 digits)
20.0 ÷ 199.9	0.1	$\pm(10\%$ of reading)
200 ÷ 1999	1	
2000 ÷ 9999	1	Indicator only

Open-circuit voltage 6.5 VDC ÷ 9 VDC

Measuring current min. 200 mA into load resistance of 2 Ω

Test lead compensation up to 20 Ω

The number of possible tests > 2000, with a fully charged battery

Automatic polarity reversal of the test voltage.

8.2.2 Resistance General 7mA

Measuring range (Ω)	Resolution (Ω)	Accuracy
0.0 ÷ 19.9	0.1	$\pm(5\%$ of reading + 3 digits)
20 ÷ 1999	1	
2000 ÷ 9999	1	Indicator only

Open-circuit voltage 6.5 VDC ÷ 9 VDC

Short-circuit current max. 8.5 mA

Test lead compensation up to 20 Ω

8.3 Ring Continuity, Polarity

Measuring range (Ω)	Resolution (Ω)	Accuracy
0.00 ÷ 19.9	0.1	$\pm(5\%$ of reading + 5 digits)
20.0 ÷ 199.9	0.1	$\pm(10\%$ of reading)
200 ÷ 1999	1	
2000 ÷ 9999	1	Indicator only

Open-circuit voltage 6.5 VDC ÷ 9 VDC

Measuring current min. 200 mA into load resistance of 2 Ω

Test lead compensation up to 20 Ω

The number of possible tests > 2000, with a fully charged battery

8.4 RCD testing

8.4.1 General data

Nominal residual current..... 10 mA, 30 mA, 100 mA, 300 mA, 500 mA, 1000 mA

Nominal residual current accuracy.... -0 / +0.1·I_Δ; I_Δ = I_{ΔN}, 2×I_{ΔN}, 5×I_{ΔN}
-0.1·I_Δ / +0; I_Δ = 0.5×I_{ΔN}
AS / NZ selected: ± 5 %

Test current shape..... Sine-wave (AC), pulsed (A), DC (B)

DC offset for pulsed test current 6 mA (typical)

RCD type G (non-delayed), S (time-delayed)

Test current starting polarity 0 ° or 180 °

Voltage range 40 V ÷ 264 V (14 Hz ÷ 500 Hz)

RCD test current selection (r.m.s. value calculated to 20ms) according to IEC 61009:

I _{ΔN} (mA)	I _{ΔN} × 1/2			I _{ΔN} × 1			I _{ΔN} × 2			I _{ΔN} × 5			RCD I _Δ		
	AC	A	B	AC	A	B	AC	A	B	AC	A	B	AC	A	B
10	5	3.5	5	10	20	20	20	40	40	50	100	100	✓	✓	✓
30	15	10.5	15	30	42	60	60	84	120	150	212	300	✓	✓	✓
100	50	35	50	100	141	200	200	282	400	500	707	1000	✓	✓	✓
300	150	105	150	300	424	600	600	848	n.a.	1500	n.a.	n.a.	✓	✓	✓
500	250	175	250	500	707	1000	1000	1410	n.a.	2500	n.a.	n.a.	✓	✓	✓
1000	500	350	500	1000	1410	n.a.	2000	n.a.	n.a.	n.a.	n.a.	n.a.	✓	✓	n.a.

n.a..... not applicable

AC type..... sine wave test current

A type..... pulsed current

B type..... smooth DC current

8.4.2 Contact voltage RCD-Uc

Measuring range according to EN61557 is 20.0 V ÷ 31.0V for limit contact voltage 25V

Measuring range according to EN61557 is 20.0 V ÷ 62.0V for limit contact voltage 50V

Measuring range (V)	Resolution (V)	Accuracy
0.0 ÷ 19.9	0.1	(-0 % / +15 %) of reading ± 10 digits
20.0 ÷ 99.9		(-0 % / +15 %) of reading

The accuracy is valid if mains voltage is stabile during the measurement and PE terminal is free of interfering voltages.

Test current..... max. 0.5×I_{ΔN}

Limit contact voltage 25 V, 50 V

Specified accuracy is valid for complete operating range.

8.4.3 Trip-out time

Complete measurement range corresponds to EN 61557 requirements.

Maximum measuring times set according to selected reference for RCD testing.

Measuring range (ms)	Resolution (ms)	Accuracy
0.0 ÷ 40.0	0.1	±1 ms
0.0 ÷ max. time *	0.1	±3 ms

* For max. time see normative references in 4.4.2 – this specification applies to max. time >40 ms.

Test current..... ½×I_{ΔN}, I_{ΔN}, 2×I_{ΔN}, 5×I_{ΔN}

$5 \times I_{\Delta N}$ is not available for $I_{\Delta N} = 1000$ mA (RCD types AC) or $I_{\Delta N} \geq 300$ mA (RCD type A,B).

$2 \times I_{\Delta N}$ is not available for $I_{\Delta N} = 1000$ mA (RCD type A,B).

$1 \times I_{\Delta N}$ is not available $I_{\Delta N} = 1000$ mA (RCD Typ B).

Specified accuracy is valid for complete operating range.

8.4.4 Trip-out current

Trip-out current

Complete measurement range corresponds to EN 61557 requirements.

Measuring range I_{Δ}	Resolution I_{Δ}	Accuracy
$0.2 \times I_{\Delta N} \div 1.1 \times I_{\Delta N}$ (AC type)	$0.05 \times I_{\Delta N}$	$\pm 0.1 \times I_{\Delta N}$
$0.2 \times I_{\Delta N} \div 1.5 \times I_{\Delta N}$ (A type, $I_{\Delta N} \geq 30$ mA)	$0.05 \times I_{\Delta N}$	$\pm 0.1 \times I_{\Delta N}$
$0.2 \times I_{\Delta N} \div 2.2 \times I_{\Delta N}$ (A type, $I_{\Delta N} < 30$ mA)	$0.05 \times I_{\Delta N}$	$\pm 0.1 \times I_{\Delta N}$
$0.2 \times I_{\Delta N} \div 2.2 \times I_{\Delta N}$ (B type)	$0.05 \times I_{\Delta N}$	$\pm 0.1 \times I_{\Delta N}$

Trip-out time

Measuring range (ms)	Resolution (ms)	Accuracy
0 ÷ 300	1	± 3 ms

Contact voltage

Measuring range (V)	Resolution (V)	Accuracy
0.0 ÷ 19.9	0.1	(-0 % / +15 %) of reading ± 10 digits
20.0 ÷ 99.9	0.1	(-0 % / +15 %) of reading

The accuracy is valid if mains voltage is stable during the measurement and PE terminal is free of interfering voltages.

Measurement can not be performed for $I_{\Delta N} = 1000$ mA (RCD type B).

Specified accuracy is valid for complete operating range.

8.5 Fault loop impedance and prospective fault current

8.5.1 No disconnecting device or FUSE selected

Fault loop impedance

Measuring range according to EN61557 is $0.25 \Omega \div 19999 \Omega$.

Measuring range (Ω)	Resolution (Ω)	Accuracy
0.00 ÷ 9.99	0.01	$\pm(5 \% \text{ of reading} + 5 \text{ digits})$
10.0 ÷ 99.9	0.1	
100 ÷ 19999	1	

Prospective fault current (calculated value)

Measuring range (A)	Resolution (A)	Accuracy
0.00 ÷ 9.99	0.01	Consider accuracy of fault loop impedance measurement
10.0 ÷ 99.9	0.1	
100 ÷ 999	1	
1.00k ÷ 9.99k	10	
10.0k ÷ 23.0k	100	

The accuracy is valid if mains voltage is stable during the measurement.

Test current (at 230 V) 6.5 A (10 ms)
 Nominal voltage range 30 V ÷ 500 V (14 Hz ÷ 500 Hz)

8.5.2 RCD selected

Fault loop impedance

Measuring range according to EN61557 is 0.46 Ω ÷ 19999 Ω .

Measuring range (Ω)	Resolution (Ω)	Accuracy *
0.00 ÷ 9.99	0.01	$\pm(5\%$ of reading + 10 digits)
10.0 ÷ 99.9	0.1	$\pm 10\%$ of reading
100 ÷ 19999	1	$\pm 10\%$ of reading

* Accuracy may be impaired in case of heavy noise on mains voltage

Prospective fault current (calculated value)

Measuring range (A)	Resolution (A)	Accuracy
0.00 ÷ 9.99	0.01	Consider accuracy of fault loop impedance measurement
10.0 ÷ 99.9	0.1	
100 ÷ 999	1	
1.00k ÷ 9.99k	10	
10.0k ÷ 23.0k	100	

Nominal voltage range 30 V ÷ 500 V (14 Hz ÷ 500 Hz)

No trip out of RCD.

R, XL values are indicative.

8.6 Line impedance / prospective short-circuit current and Voltage drop

Line impedance

Measuring range according to EN61557 is 0.25 Ω ÷ 19.9 k Ω .

Measuring range (Ω)	Resolution (Ω)	Accuracy
0.00 ÷ 9.99	0.01	$\pm(5\%$ of reading + 5 digits)
10.0 ÷ 99.9	0.1	
100 ÷ 999	1	
1.00k ÷ 9.99k	10	
10.0k ÷ 19.9k	100	

Prospective short-circuit current (calculated value)

Measuring range (A)	Resolution (A)	Accuracy
0.00 ÷ 0.99	0.01	Consider accuracy of line impedance measurement
1.0 ÷ 99.9	0.1	
100 ÷ 999	1	
1.00k ÷ 99.99k	10	
100k ÷ 199k	1000	

Test current (at 230 V) 6.5 A (10 ms)

Nominal voltage range 30 V ÷ 500 V (14 Hz ÷ 500 Hz)

R, XL values are indicative.

Voltage drop (calculated value)

Measuring range (%)	Resolution (%)	Accuracy
0.0 ÷ 99.9	0.1	Consider accuracy of line impedance measurement

Z_{REF} measuring range.....0.00 Ω ÷ 20.0 Ω

8.7 Voltage, frequency, and phase rotation

8.7.1 Phase rotation

Nominal system voltage range..... 100 V_{AC} ÷ 550 V_{AC}

Nominal frequency range..... 14 Hz ÷ 500 Hz

Result displayed 1.2.3 or 3.2.1

8.7.2 Voltage

Measuring range (V)	Resolution (V)	Accuracy
0 ÷ 550	1	±(2 % of reading + 2 digits)

Result type..... True r.m.s. (trms)

Nominal frequency range..... 0 Hz, 14 Hz ÷ 500 Hz

8.7.3 Frequency

Measuring range (Hz)	Resolution (Hz)	Accuracy
0.00 ÷ 999.99	0.01	±(0.2 % of reading + 1 digit)

Nominal voltage range..... 10 V ÷ 550 V

8.8 Online terminal voltage monitor

Measuring range (V)	Resolution (V)	Accuracy
10 ÷ 550	1	±(2 % of reading + 2 digits)

8.9 Earth resistance

Earth resistance three-wire method

Measuring range according to EN61557 is 0.67 Ω ÷ 9999 Ω

Measuring range (Ω)	Resolution (Ω)	Accuracy
0.00 ÷ 19.99	0.01	±(3 % of reading + 3 digits)
20.0 ÷ 199.9	0.1	
200 ÷ 1999	1	± 5 % of reading
2000 ÷ 9999	1	± 10 % of reading

Additional spike resistance error if

Rc max. or Rp max. is exceeded $\pm(5\%$ of reading + 10 digits)

Rc max. 100 R_E or 50 k Ω (whichever is lower)

Rp max. 100 R_E or 50 k Ω (whichever is lower)

Automatic test of probe resistance yes

Additional error

at 3 V voltage noise (50 Hz) $\pm(5\%$ of reading +10 digits)

Automatic test of voltage noise yes

Noise voltage indication threshold 1 V (<50 Ω , worst case)

Open-terminal test voltage 40 V_{AC}

Test voltage frequency 125 Hz / 150 Hz

Short-circuit test current < 20 mA

Specific earth resistance

Measuring range (Ω m)	Resolution (Ω m)	Accuracy
0.0 ÷ 99.9	0.1	See accuracy note
100 ÷ 999	1	
1.00k ÷ 9.99k	0.01k	
10.0k ÷ 99.9k	0.1k	
>100k	1k	

Measuring range (Ω ft)	Resolution (Ω ft)	Accuracy
0.0 ÷ 99.9	0.1	See accuracy note
100 ÷ 999	1	
1.00k ÷ 9.99k	0.01k	
10.0k ÷ 99.9k	0.1k	
>100k	1k	

Principle:

$$\rho = 2 \cdot \pi \cdot \text{distance} \cdot R_e,$$

with R_e as measured resistance in 4-wire method.

Accuracy note:

- Accuracy of the specific earth resistance result depends on measured resistance R_e and is as follows:

Measuring range (Ω)	Accuracy
1.00 ÷ 1999	$\pm 5\%$ of measured
2000 ÷ 19.99k	$\pm 10\%$ of measured
>20k	$\pm 20\%$ of measured

Additional error

See *Earth resistance three-wire method*.

8.10 2 Ω line/loop impedance

8.10.1 High precision line impedance

Measuring range according to EN61557 is 5.0 ÷ 1999 mΩ

Measuring range (mΩ)	Resolution (mΩ)	Accuracy
0.1 ÷ 199.9	0.1	±(5 % + 1 mΩ)
200 ÷ 1999	1	

Nominal voltage range 100 V ÷ 440 V

Nominal frequency 50 Hz

Maximum test current (at 400V)..... 267 A (10 ms)

Calculation of prospective short-circuit current (standard voltage value):

$$I_K = \frac{230 \text{ V}}{Z} \quad U_{L-N} = 230 \text{ V} \pm 10 \%$$

$$I_K = \frac{400 \text{ V}}{Z} \quad U_{L-L} = 400 \text{ V} \pm 10 \%$$

Calculation of prospective short-circuit current (non-standard voltage value):

$$I_{KMAX3ph} = \frac{C_{MAX} \times U_{N(L-L)}}{\sqrt{3}} \times \frac{2}{Z_{L-L}} \quad I_{KMIN3ph} = \frac{C_{MIN} \times U_{N(L-L)}}{\sqrt{3}} \times \frac{2}{Z_{(L-L)HOT}}$$

$$I_{KMAX2ph} = \frac{C_{MAX} \times U_{N(L-L)}}{Z_{L-L}} \quad I_{KMIN2ph} = \frac{C_{MIN} \times U_{N(L-L)}}{Z_{(L-L)HOT}}$$

$$I_{KMAX(L-N)} = \frac{C_{MAX} \times U_{N(L-N)}}{Z_{L-N}} \quad I_{KMIN(L-N)} = \frac{C_{MIN} \times U_{N(L-N)}}{Z_{(L-N)HOT}}$$

$$Z_{L-L} = \sqrt{R_{L-L}^2 + X_{L-L}^2} \quad Z_{(L-L)HOT} = \sqrt{(1.5 \times R_{L-L})^2 + X_{L-L}^2}$$

$$Z_{L-N} = \sqrt{R_{L-N}^2 + X_{L-N}^2} \quad Z_{(L-N)HOT} = \sqrt{(1.5 \times R_{L-N})^2 + X_{L-N}^2}$$

	$U_{N(L-N)} = 230 \text{ V} \pm 10 \%$ $U_{N(L-L)} = 400 \text{ V} \pm 10 \%$	$230 \text{ V} < U_N < 400 \text{ V}$
C_{MAX}	1.05	1.10
C_{MIN}	0.95	1.00

8.10.2 High precision fault loop impedance

Measuring range according to EN61557 is 5.0 ÷ 1999 mΩ

Measuring range (mΩ)	Resolution (mΩ)	Accuracy
0.0 ÷ 199.9	0.1	±(5 % + 1 mΩ)
200 ÷ 1999	1	

Nominal voltage range 100 V ÷ 440 V

Nominal frequency 50 Hz

Maximum test current (at 230 V)..... 154 A (10 ms)

Calculation of prospective short-circuit current (standard voltage value):

$$I_K = \frac{230 \text{ V}}{Z} \quad U_{L-PE} = 230 \text{ V} \pm 10 \%$$

Calculation of prospective short-circuit current (non-standard voltage value):

$$I_{KMAX(L-PE)} = \frac{C_{MAX} \times U_{N(L-PE)}}{Z_{L-PE}}$$

$$I_{KMIN(L-PE)} = \frac{C_{MIN} \times U_{N(L-PE)}}{Z_{(L-PE)HOT}}$$

$$Z_{L-PE} = \sqrt{R_{L-PE}^2 + X_{L-PE}^2}$$

$$Z_{(L-PE)HOT} = \sqrt{(1.5 \times R_{L-PE})^2 + X_{L-PE}^2}$$

	$U_{N(L-PE)} = 230 \text{ V} \pm 10 \%$	$230 \text{ V} < U_N < 400 \text{ V}$
C_{MAX}	1.05	1.10
C_{MIN}	0.95	1.00

8.10.3 Contact voltage

Measuring range (V)	Resolution (V)	Accuracy
0 ÷ 100	1	±(10 % + 3 digits)

8.11 Varistor test

DC voltage

Measuring range (V)	Resolution (V)	Accuracy
0 ÷ 1000	1	±(3 % of reading + 3 digits)

AC voltage

Measuring range (V)	Resolution (V)	Accuracy
0 ÷ 625	1	Consider accuracy of DC voltage

Measurement principle..... d.c. voltage ramp

Test voltage slope..... 500 V/s

Threshold current..... 1 mA

8.12 General data

Power supply voltage.....	9 V _{DC} (6×1.5 V battery or accu, size AA)
Operation.....	typical 13 h
Charger socket input voltage	12 V ± 10 %
Charger socket input current.....	400 mA max.
Battery charging current.....	250 mA (internally regulated)
Overvoltage category.....	600 V CAT III, 300 V CAT IV
Protection classification	double insulation
Pollution degree.....	2
Protection degree	IP 40
Display	320x240 dots matrix display with backlight
Dimensions (w × h × d).....	23 cm × 10.3 cm × 11.5 cm
Weight	1.32 kg, without battery cells
Reference conditions	
Reference temperature range.....	10 °C ÷ 30 °C
Reference humidity range.....	40 %RH ÷ 70 %RH
Operation conditions	
Working temperature range	0 °C ÷ 40 °C
Maximum relative humidity	95 %RH (0 °C ÷ 40 °C), non-condensing
Storage conditions	
Temperature range.....	-10 °C ÷ +70 °C
Maximum relative humidity	90 %RH (-10 °C ÷ +40 °C) 80 %RH (40 °C ÷ 60 °C)
Locator.....	supports inductive mode
Maximum operation voltage.....	440 V a.c.
Communication transfer speed	
RS 232.....	115200 baud
USB	256000 baud

The error in operating conditions could be at most the error for reference conditions (specified in the manual for each function) +1 % of measured value + 1 digit, unless otherwise specified in the manual for particular function.

A Appendix A - Fuse table

A.1 Fuse table - IPSC

Fuse type NV

Rated current (A)	Disconnection time [s]				
	35m	0.1	0.2	0.4	5
	Min. prospective short-circuit current (A)				
2	32.5	22.3	18.7	15.9	9.1
4	65.6	46.4	38.8	31.9	18.7
6	102.8	70	56.5	46.4	26.7
10	165.8	115.3	96.5	80.7	46.4
16	206.9	150.8	126.1	107.4	66.3
20	276.8	204.2	170.8	145.5	86.7
25	361.3	257.5	215.4	180.2	109.3
35	618.1	453.2	374	308.7	169.5
50	919.2	640	545	464.2	266.9
63	1217.2	821.7	663.3	545	319.1
80	1567.2	1133.1	964.9	836.5	447.9
100	2075.3	1429	1195.4	1018	585.4
125	2826.3	2006	1708.3	1454.8	765.1
160	3538.2	2485.1	2042.1	1678.1	947.9
200	4555.5	3488.5	2970.8	2529.9	1354.5
250	6032.4	4399.6	3615.3	2918.2	1590.6
315	7766.8	6066.6	4985.1	4096.4	2272.9
400	10577.7	7929.1	6632.9	5450.5	2766.1
500	13619	10933.5	8825.4	7515.7	3952.7
630	19619.3	14037.4	11534.9	9310.9	4985.1
710	19712.3	17766.9	14341.3	11996.9	6423.2
800	25260.3	20059.8	16192.1	13545.1	7252.1
1000	34402.1	23555.5	19356.3	16192.1	9146.2
1250	45555.1	36152.6	29182.1	24411.6	13070.1

Fuse type gG

Rated current (A)	Disconnection time [s]				
	35m	0.1	0.2	0.4	5
	Min. prospective short-circuit current (A)				
2	32.5	22.3	18.7	15.9	9.1
4	65.6	46.4	38.8	31.9	18.7
6	102.8	70	56.5	46.4	26.7
10	165.8	115.3	96.5	80.7	46.4
13	193.1	144.8	117.9	100	56.2
16	206.9	150.8	126.1	107.4	66.3
20	276.8	204.2	170.8	145.5	86.7
25	361.3	257.5	215.4	180.2	109.3
32	539.1	361.5	307.9	271.7	159.1
35	618.1	453.2	374	308.7	169.5
40	694.2	464.2	381.4	319.1	190.1
50	919.2	640	545	464.2	266.9
63	1217.2	821.7	663.3	545	319.1
80	1567.2	1133.1	964.9	836.5	447.9
100	2075.3	1429	1195.4	1018	585.4

Fuse type B

Rated current (A)	Disconnection time [s]				
	35m	0.1	0.2	0.4	5
	Min. prospective short-circuit current (A)				
6	30	30	30	30	30
10	50	50	50	50	50
13	65	65	65	65	65
16	80	80	80	80	80
20	100	100	100	100	100
25	125	125	125	125	125
32	160	160	160	160	160
40	200	200	200	200	200
50	250	250	250	250	250
63	315	315	315	315	315

Fuse type C

Rated current (A)	Disconnection time [s]				
	35m	0.1	0.2	0.4	5
	Min. prospective short-circuit current (A)				
0.5	5	5	5	5	2.7
1	10	10	10	10	5.4
1.6	16	16	16	16	8.6
2	20	20	20	20	10.8
4	40	40	40	40	21.6
6	60	60	60	60	32.4
10	100	100	100	100	54
13	130	130	130	130	70.2
16	160	160	160	160	86.4
20	200	200	200	200	108
25	250	250	250	250	135
32	320	320	320	320	172.8
40	400	400	400	400	216
50	500	500	500	500	270
63	630	630	630	630	340.2

Fuse type K

Rated current (A)	Disconnection time [s]				
	35m	0.1	0.2	0.4	
	Min. prospective short-circuit current (A)				
0.5	7.5	7.5	7.5	7.5	
1	15	15	15	15	
1.6	24	24	24	24	
2	30	30	30	30	
4	60	60	60	60	
6	90	90	90	90	
10	150	150	150	150	
13	195	195	195	195	
16	240	240	240	240	
20	300	300	300	300	
25	375	375	375	375	
32	480	480	480	480	

Fuse type D

Rated current (A)	Disconnection time [s]				
	35m	0.1	0.2	0.4	5
	Min. prospective short-circuit current (A)				
0.5	10	10	10	10	2.7
1	20	20	20	20	5.4
1.6	32	32	32	32	8.6
2	40	40	40	40	10.8
4	80	80	80	80	21.6
6	120	120	120	120	32.4
10	200	200	200	200	54
13	260	260	260	260	70.2
16	320	320	320	320	86.4
20	400	400	400	400	108
25	500	500	500	500	135
32	640	640	640	640	172.8

A.2 Fuse table - impedances (UK)**Fuse type B**

Rated current (A)	Disconnection time [s]	
	0.4	5
	Max. loop impedance (Ω)	
3	12,264	12,264
6	6,136	6,136
10	3,68	3,68
16	2,296	2,296
20	1,84	1,84
25	1,472	1,472
32	1,152	1,152
40	0,92	0,92
50	0,736	0,736
63	0,584	0,584
80	0,456	0,456
100	0,368	0,368
125	0,296	0,296

Fuse type C

Rated current (A)	Disconnection time [s]	
	0.4	5
	Max. loop impedance (Ω)	
6	3,064	3,064
10	1,84	1,84
16	1,152	1,152
20	0,92	0,92
25	0,736	0,736
32	0,576	0,576
40	0,456	0,456
50	0,368	0,368
63	0,288	0,288
80	0,232	0,232
100	0,184	0,184
125	0,144	0,144

Fuse type D

Rated current (A)	Disconnection time [s]	
	0.4	5
	Max. loop impedance (Ω)	
6	1,536	1,536
10	0,92	0,92
16	0,576	0,576
20	0,456	0,456
25	0,368	0,368
32	0,288	0,288
40	0,232	0,232
50	0,184	0,184
63	0,144	0,144
80	0,112	0,112
100	0,088	0,088
125	0,072	0,072

Fuse type BS 1361

Rated current (A)	Disconnection time [s]	
	0.4	5
	Max. loop impedance (Ω)	
5	8,36	13,12
15	2,624	4
20	1,36	2,24
30	0,92	1,472
45		0,768
60		0,56
80		0,4
100		0,288

Fuse type BS 88				Fuse type BS 1362			
Rated current (A)	Disconnection time [s]			Rated current (A)	Disconnection time [s]		
		0.4	5			0.4	5
	Max. loop impedance (Ω)				Max. loop impedance (Ω)		
6		6,816	10,8	3		13,12	18,56
10		4,088	5,936	13		1,936	3,064
16		2,16	3,344	Fuse type BS 3036			
20		1,416	2,328				
25		1,152	1,84				
32		0,832	1,472				
40			1,08				
50			0,832				
63			0,656				
80			0,456				
100			0,336				
125			0,264				
160			0,2	5		7,664	14,16
200			0,152	15		2,04	4,28
				20		1,416	3,064
				30		0,872	2,112
				45			1,272
				60			0,896
				100			0,424

All impedances are scaled with factor 0.8.

B Appendix B - Accessories for specific measurements

The table below presents standard and optional accessories required for specific measurement. The accessories marked as optional may also be standard ones in some sets. Please see attached list of standard accessories for your set or contact your distributor for further information.

Function	Suitable accessories (Optional with ordering code A...)
Insulation	<input type="checkbox"/> Universal test cable <input type="checkbox"/> Tip commander (A 1176)
Continuity, general 200 mA and 7 mA	<input type="checkbox"/> Universal test cable <input type="checkbox"/> Tip commander (A 1176) <input type="checkbox"/> Probe test lead 4m (A 1012)
Continuity R2, R1+R2	<input type="checkbox"/> Universal test cable <input type="checkbox"/> Tip commander (A 1176) <input type="checkbox"/> Probe test lead 4m (A 1012) <input type="checkbox"/> Plug cable
Ring continuity	<input type="checkbox"/> Universal test cable <input type="checkbox"/> Tip commander (A 1176) <input type="checkbox"/> Plug cable <input type="checkbox"/> Ring adapter (A 1214)
Polarity	<input type="checkbox"/> Universal test cable <input type="checkbox"/> Tip commander (A 1176) <input type="checkbox"/> Probe test lead 4m (A 1012)
Line impedance / Voltage drop	<input type="checkbox"/> Universal test cable <input type="checkbox"/> Plug cable <input type="checkbox"/> Tip commander (A 1176)
Fault loop impedance	<input type="checkbox"/> Universal test cable <input type="checkbox"/> Plug cable <input type="checkbox"/> Tip commander (A 1176)
RCD testing	<input type="checkbox"/> Universal test cable <input type="checkbox"/> Plug cable
Phase sequence	<input type="checkbox"/> Universal test cable <input type="checkbox"/> Three-phase cable (A 1110) <input type="checkbox"/> Three-phase adapter (A 1111)
Voltage, frequency	<input type="checkbox"/> Universal test cable <input type="checkbox"/> Plug cable <input type="checkbox"/> Tip commander (A 1176)
Earth resistance	<input type="checkbox"/> Universal test cable
Specific earth resistance	<input type="checkbox"/> ρ -Adapter (A1199)
Locator	<input type="checkbox"/> Receiver R10K (A 1191) <input type="checkbox"/> 1000 A current clamp (A 1019) <input type="checkbox"/> 200 A current clamp (A 1074) <input type="checkbox"/> Clamp interface (A 1068) <input type="checkbox"/> Selective probe (A 1192)
2 Ω line/loop impedance	<input type="checkbox"/> Impedance adapter (A1143)
Varistor test	<input type="checkbox"/> Universal test cable

C Appendix C – Locator receiver R10K

The highly sensitive hand-held **receiver R10K** detects the fields caused by the currents in the traced line. It generates sound and visual output according to the signal intensity. The operating mode switch in the head detector should always be set in IND (inductive) mode. The CAP (capacitive) operating mode is intended for operating in combination with other Metrel measuring equipment.

The built in field detector is placed in the front end of the receiver. External detectors can be connected via the rear connector.

Traced object must be energized when working with the EurotestAT.

Detectors	Operation
In built inductive sensor (IND)	Tracing hidden wires.
Current clamp	Connected trough the rear connector. Locating wires.
Selective probe	Connected trough the rear connector. Locating fuses in fuse cabinets.



Figure C.1: Receiver R10K

The user can choose between three sensitivity levels (low, middle and high). An extra potentiometer is added for fine sensitivity adjustment. A buzzer sound and 10-level LED bar graph indicator indicates the strength of the magnetic field e.g. proximity of the traced object.

Note:

- The field strength can vary during tracing. The sensitivity should always be adjusted to optimum for each individual tracing.

C.1 Tracing principles

C.1.1 Positioning the receiver

The receiver has to be correctly positioned (see the figures below) to obtain the best results! Also wire position can be defined this way.



Figure C.2: Detection of electromagnetic field

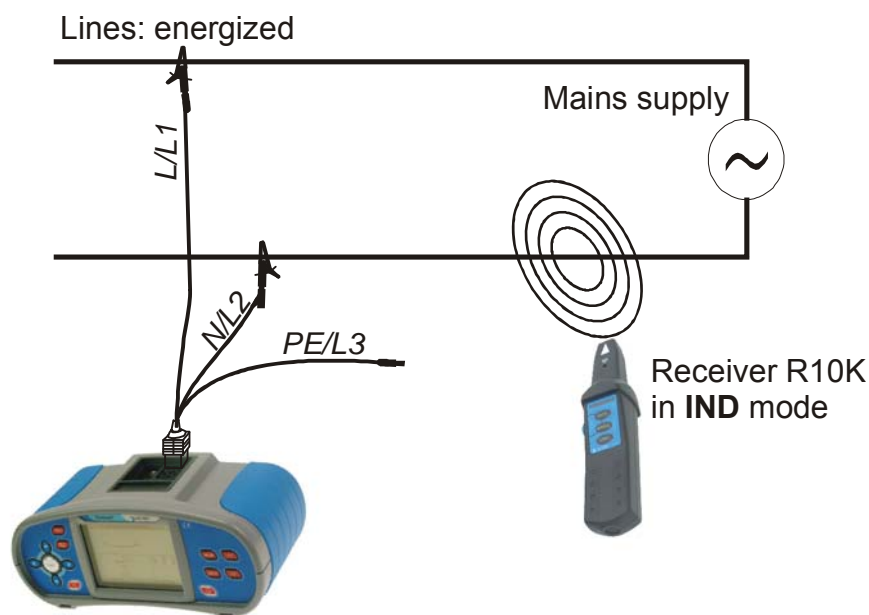

Figure C.3: The EurotestAT as a signal source for tracing lines

C.1.2 Positioning current clamp

Whenever it is possible to embrace the traced wire it is recommended to use the appropriate current clamp instead of the receiver inductive sensor (see figure below). By using the clamp, the signal selectivity will considerably improve. Always keep maximum distance between current clamp and R10K.

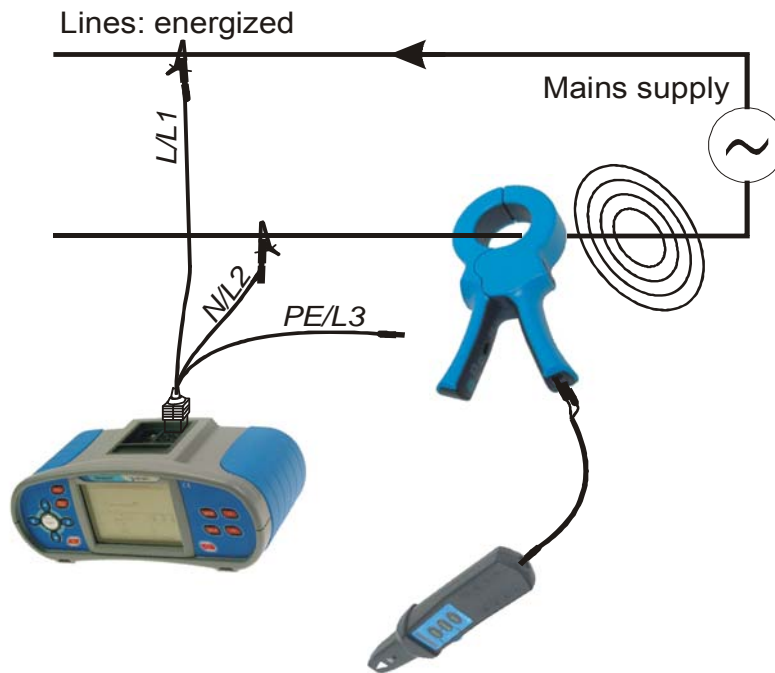

Figure C.4: Transmitter as active load, clamp used instead of inductive sensor

C.1.3 Positioning selective probe

For searching a fuse in a group the selective probe shall be used. The wire or housing of the fuse must be touched at the right angle with it. Find the best signal by rotating the probe.

Keep the maximum distance between R10K and selective probe.

Note:

- Keep fingers behind the probe barrier to avoid electric shock and access of live parts.

C.2 Detection distances for different connections

Connection	Distance up to
Connection between L and N wire in same wall socket	40 cm
Connection between L wire in one wall socket and N wire in other wall socket with separated conduits*	2 m

* WARNING! Avoid connection of the EurotestAT in trace mode between line and PE of different wall sockets, electric shock hazard!

C.3 R10K power supply

The receiver R10K is supplied by a 9 V alkaline battery (IEC 6LR61).

C.4 Maintenance

Remove battery from R10K when not in use for a longer time.

Apply maintenance instructions from chapter 7 of this document.

D Appendix D - IT supply systems

In order for operator to be familiar enough with measurements in and their typical applications in IT supply system it is advisable to read Metrel handbook *Measurements on IT power supply systems*.

D.1 Standard references

EN 60364-4-41, EN 60364-6, EN 60364-7-710, BS 7671

D.2 Fundamentals

IT supply system is mains supply system that is insulated from ground (PE) – it is ungrounded supplying system. The system is without direct connection to the ground or the connection is provided through relatively high impedance. It is applied mostly in areas where additional protection to electric shock is required. Typical places are medical surgery rooms.

IT supply system also omits any grounding currents except leakages, and in this way there aren't problems with step voltage, i.e. voltage drop in one step, neither high energy sparking in Ex areas.

In normal cases the high impedance to the ground exists and is formed by capacitances of supply wires to the ground plus capacitances between primary and secondary windings of IT supply transformer. Minor part is formed by Y capacitors (EMC) in mains section of connected equipment. Selecting appropriate transformer, installation cabling and selection of optional high impedance connection to ground can control maximum leakage current. Depending on application area additional impedance to the ground can be applied as presented in *figure D.1* or through special loading equipment. Value of the impedance should begin from 100 Ω .

IT system represents additional level of protection to electric shock. In the case of a failure of any line insulation to the PE through equipment failure, wrong application or procedure, this system is still safe but converted to TN / TT type. However, additional failure is hazardous, which means that the insulation has to be continuously checked and repaired immediately after detected failure.

Supplementary to other protection devices the IT system normally contains insulation monitoring device (IMD) or system that alarms when insulation resistance or impedance is below set threshold. Threshold value depends on environment. Typical value for medical installations is 55 k Ω .

In some countries it is not enough to trace insulation resistance of IT supply system to the ground, they require tracing of system capacitance, too.

IEC 60364-4-41 (©IEC): In IT systems live parts shall be insulated from earth or connected to earth through sufficiently high impedance. This connection may be made either at the neutral point or midpoint of the system or at an artificial neutral point. The latter may be connected directly to earth if the resulting impedance to earth is sufficiently high at the system frequency. Where no neutral point or mid-point exists a line conductor may be connected to earth through high impedance.

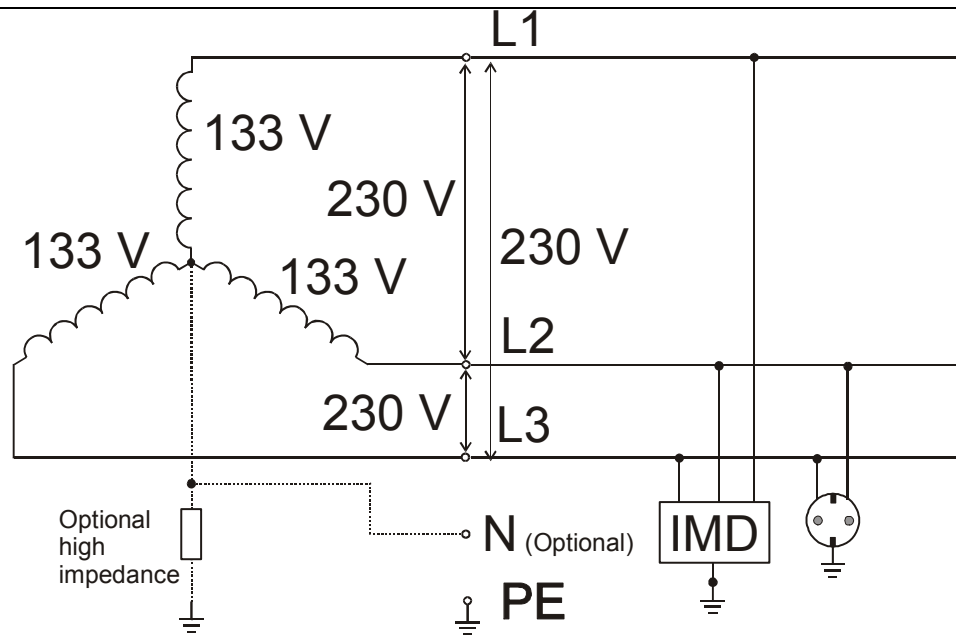

Figure D.1: General IT supply system

- Three phase star connection, optional delta connection.
- Optional neutral line.
- Single-phase connection is also possible.
- Various system voltages – not only three phase 230 V as indicated above.
- One faulty connection of any line to PE is treated as first fault and is regular but it has to be repaired as soon as possible.
- **IEC 60364-4-41:** In IT systems the following monitoring devices and protective devices may be used:
 - Insulation monitoring devices (IMDs),
 - Residual current monitoring devices (RCMs),
 - Insulation fault location systems,
 - Overcurrent protective devices,
 - Residual current protective devices (RCDs).

NOTE: Where a residual current operating device (RCD) is used, tripping of the RCD in the event of a first fault cannot be excluded due to capacitive leakage currents.

Testing of IT supply system is slightly different to standard tests in TN / TT system.

D.3 Measurement guides

The user has to select the IT supply system in the instrument before testing it. The procedure for selecting the IT supply system is defined in chapter 4.4.2 *Supply system, Isc factor, RCD standard*. Once the IT system is selected the instrument can be used immediately. The instrument keeps selected IT system when it is turned off.

When the instrument detects appropriate voltage levels for selected IT system, the terminal voltage monitor shows IT system icon .

D.3.1 MI 3101 test functions and IT systems

The table below contains functions of the instrument including compatibility notes related to the IT system.

IT system functions	Note
Voltage	
Voltage	Symbols modified for IT system, see <i>figure D.2</i> .
Phase rotation	For three phase system only, automatic detection.
RCD functions	
RCD - Uc	Not applicable.
RCD - Trip out Time t	
RCD - Tripping Current	
RCD – Automatic test	
Loop functions	
Fault Loop Impedance	Not applicable.
Fault Loop Prospective Short-circuit Current	
Line functions	
Line Impedance	Impedance $Z_{\text{Line-Line}}$.
Line Prospective Short-circuit Current	I_{SC} for rated $U_{\text{Line-Line}}$.
Continuity functions	Independent of selected supply system.
Insulation Resistance	Independent of selected supply system.
Earth resistance	Independent of selected supply system.
PE test probe	Active, but does not inhibit selected test if voltage is detected.

D.3.1.1 Voltage measurements

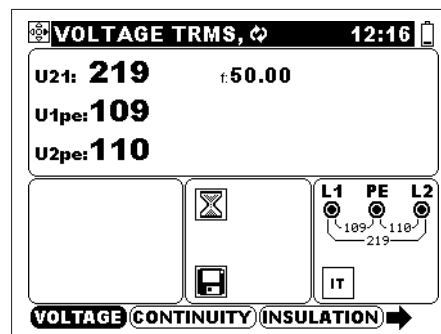

Figure D.2: Voltage measurements

Displayed results for **single phase** system:

U21..... Voltage between line conductors,

U1pe..... Voltage between line 1 and protective conductor,

U2pe..... Voltage between line 2 and protective conductor.

D.3.1.2 Line impedance

See chapter 5.5, the measurement is the same; only terminal voltage monitor indication corresponds to IT system.

E Appendix E - Reduced low voltage supply systems

E.1 Standard reference

BS7671

E.2 Fundamentals

Special supply systems are applied where inherent protection to electric shock is required but no SELV used. Reduced low voltage supply with ground reference can be used for this purpose.

There are two options with 110 V nominal voltage.

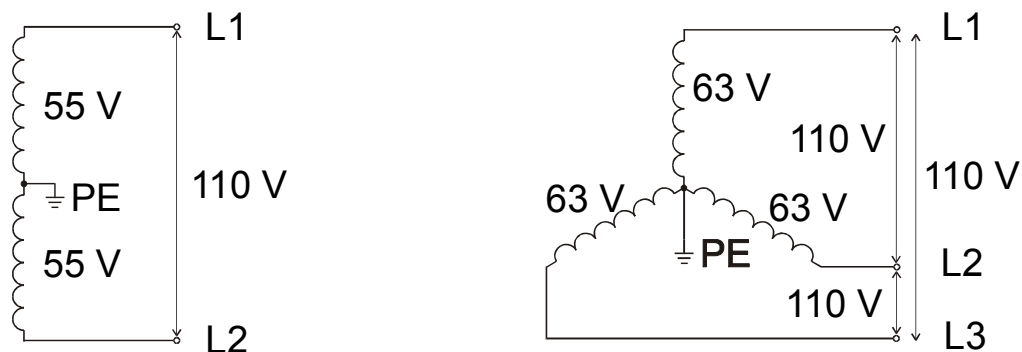

- Single phase with center tap connected to PE (i.e. 2 x 55 V).
- No neutral line.
- Three phase star connection, center tap connected to PE (i.e. 3 x 63 V).
- No neutral line.

Figure E.1: General reduced low voltage supply systems

E.3 MI 3101 guides

The user has to select the reduced low voltage supply system in the instrument before testing it. The procedure for selecting the reduced low voltage supply system is defined in chapter 4.4.2 *Supply system, Isc factor, RCD standard*. Once the reduced low voltage system is selected the instrument can be used immediately. The instrument keeps selected reduced low voltage system when it is turned off.

When the instrument detects appropriate voltage levels for selected reduced low voltage system, the terminal voltage monitor shows reduced low voltage system icon RV.

E.3.1 MI 3101 functions and reduced low voltage systems

The table below contains EurotestAT functions intended for test and measurement of supply systems with compatibility notes related to the reduced low voltage system.

Reduced low voltage system functions	Note
Voltage	
Voltage	Symbols modified for reduced low voltage system.
Phase rotation	Three-phase system automatic detected.
RCD functions	
RCD – Contact voltage U_c	For both possibilities, L1-PE and L2-PE.
RCD - Trip out time t	
RCD - Tripping current	
RCD – Automatic test	
Loop functions	
Fault Loop Impedance	Both fault loops, Z_1 (L1-PE) and Z_2 (L2-PE).
Fault Loop Prospective Short-circuit Current	I_{SC1} and I_{SC2} for both fault loops.
Line functions	
Line Impedance	Impedance $Z_{Line-Line}$.
Line Prospective Short-circuit Current	I_{SC} for $U_{Line-Line} = 110$ V.
Continuity functions	Independent of selected supply system.
Insulation Resistance	Independent of selected supply system.
Earth resistance	Independent of selected supply system.
PE test probe	Disabled.

E.3.1.1 Voltage measurements

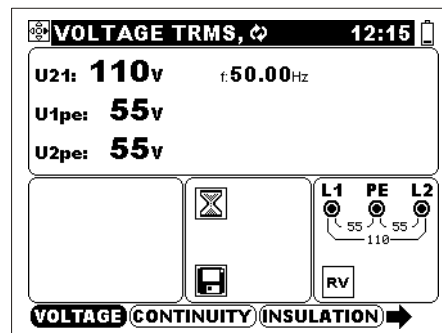

Figure E.2: Voltage measurements

Displayed results for **single phase** system:

U21..... Voltage between line conductors

U1pe..... Voltage between line 1 and protective conductors

U2pe..... Voltage between line 2 and protective conductors

E.3.1.2 RCD tests

Maximum regular RCD test current is 1 A r.m.s. (1.4 A peak) and can be achieved only when fault loop impedance is lower than 1 Ω .

Tests are carried out for both combination L1-PE and L2-PE automatically. Each individual test result is accompanied with appropriate indication.

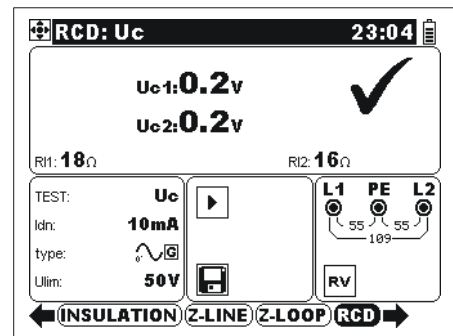

Figure E.3: RCD Uc test

If input voltage is out of range it is displayed on terminal voltage monitor, together with the indicator of disabled test

E.3.1.3 Line impedance test

Measured impedance represents Line-Line impedance (Z_{L1-L2}). Nominal system voltage for calculation of I_{PSC} is set to 110 V.

Nominal system voltage range for line impedance measurement is 90 V to 121 V. If input voltage is out of range it is displayed on terminal voltage monitor, together with the indicator of disabled test .

E.3.1.4 Fault loop impedance tests

Definition of nominal system voltage for calculation of I_{PSC} is changed to:

- 55 V for single-phase center-tap system selected,
- 63 V for three-phase system selected.

Tests can be carried out for both combination L1-PE and L2-PE. Each individual test result is accompanied with appropriate indication.

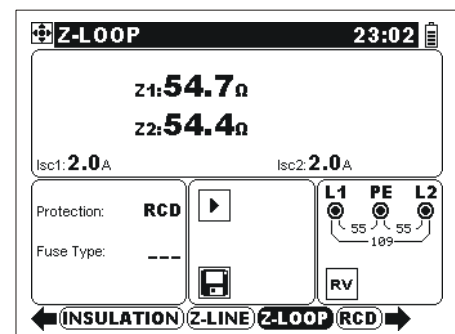

Figure E.4: Fault loop impedance

Nominal input voltages are:

- (44 V \leq U_{inp} < 61 V) for single-phase 55 V system
- (56 V \leq U_{inp} \leq 70 V) for three-phase 63 V system

If input voltage is out of range it is displayed on terminal voltage monitor, together with the indicator of disabled test .

E.4 Technical specifications

Only those technical specifications are listed below that are different to specifications from chapter 8 of this document.

E.4.1 RCD

General

Nominal differential currents	10 mA, 30 mA, 100 mA, 300 mA, 500 mA, 1 A
Accuracy of actual differential currents:	-0 / +0.1· I_{Δ} for $I_{\Delta} = I_{\Delta N}, 2 \cdot I_{\Delta N}, 5 \cdot I_{\Delta N}$ -0.1· $I_{\Delta N}$ / +0 for $I_{\Delta} = 0.5 \cdot I_{\Delta N}$
Maximum nominal differential currents	1000 mA for $I_{\Delta N}$
for declared accuracy:	500 mA for $2 \cdot I_{\Delta N}$ 100 mA for $5 \cdot I_{\Delta N}$
Maximum test current:	1 A (for Z-LOOP < 1 Ω)
Test current shape	sine wave (AC), pulsed (A), DC (B)
DC offset for pulsed test current	6 mA (typical)
RCD type	G (non-delayed), S (time-delayed)
Test current starting polarity	0° or 180°
Nominal input voltage	55 V / 63 V / 14 Hz ÷ 500 Hz
Test possibilities	L1 - PE and L2 - PE

Contact voltage U_c

Measuring range according to EN61557 is 20.0 V ÷ 31.0 V (limit contact voltage 25 V).

Measuring range according to EN61557 is 20.0 V ÷ 62.0 V (limit contact voltage 50 V).

Measuring range (V)	Resolution (V)	Accuracy
0.0 ÷ 19.9	0.1	(-0 % / +15 %) of reading ± 10 digits
20.0 ÷ 99.9		(-0 % / +15 %) of reading

The accuracy is valid if mains voltage is stable during the measurement and PE terminal is free of interfering voltages.

Test current.....	< 0.5 $I_{\Delta N}$
Limit contact voltage	25 V or 50 V
Contact voltage is calculated to	$I_{\Delta N}$ (standard type) or to $2I_{\Delta N}$ (selective type).

Trip out time

Complete measurement range corresponds to EN 61557 requirements.

Maximum measuring times set according to selected reference for RCD testing.

Measuring range (ms)	Resolution (ms)	Accuracy
0.0 ÷ 40.0	0.1	±1 ms
0.0 ÷ max. time *	0.1	±3 ms

* For max. time see normative references in 4.4.2 – this specification applies to max. time >40 ms.

Test current.....	$\frac{1}{2} \times I_{\Delta N}, I_{\Delta N}, 2 \times I_{\Delta N}, 5 \times I_{\Delta N}$
$5 \times I_{\Delta N}$ is not applicable for $I_{\Delta N} \geq 300$ mA (RCD types AC,A,B).	
$2 \times I_{\Delta N}$ is not applicable for $I_{\Delta N} \geq 500$ mA (RCD type AC) or $I_{\Delta N} \geq 300$ mA (RCD type A,B).	
$I_{\Delta N}$ is not applicable for $I_{\Delta N} \geq 500$ mA (RCD type A,B).	

Trip-out current

Trip-out current

Complete measurement range corresponds to EN 61557 requirements.

Measuring range I_{Δ}	Resolution I_{Δ}	Accuracy
$0.2 \times I_{\Delta N} \div 1.1 \times I_{\Delta N}$ (AC type)	$0.05 \times I_{\Delta N}$	$\pm 0.1 \times I_{\Delta N}$
$0.2 \times I_{\Delta N} \div 1.5 \times I_{\Delta N}$ (A type, $I_{\Delta N} \geq 30$ mA)	$0.05 \times I_{\Delta N}$	$\pm 0.1 \times I_{\Delta N}$
$0.2 \times I_{\Delta N} \div 2.2 \times I_{\Delta N}$ (A type, $I_{\Delta N} < 30$ mA)	$0.05 \times I_{\Delta N}$	$\pm 0.1 \times I_{\Delta N}$
$0.2 \times I_{\Delta N} \div 2.2 \times I_{\Delta N}$ (B type)	$0.05 \times I_{\Delta N}$	$\pm 0.1 \times I_{\Delta N}$

Trip-out time

Measuring range (ms)	Resolution (ms)	Accuracy
$0 \div 300$	1	± 3 ms

Contact voltage

Measuring range (V)	Resolution (V)	Accuracy
$0.0 \div 19.9$	0.1	(-0 % / +15 %) of reading ± 10 digits
$20.0 \div 99.9$	0.1	(-0 % / +15 %) of reading

*The accuracy is valid if mains voltage is stable during the measurement and PE terminal is free of interfering voltages.

$I_{\Delta N}$ is not applicable for $I_{\Delta N} \geq 500$ mA (RCD type A,B).

U_{CI} voltage is calculated to tripping current I_{Δ} .

E.4.2 Fault loop impedance and prospective short-circuit current**Fuse or no circuit breaker selected**

Fault loop impedance

Measuring range according to EN61557 is $0.32 \Omega \div 19999 \Omega$.

Measuring range (Ω)	Resolution (Ω)	Accuracy
$0.00 \div 9.99$	0.01	$\pm(10 \%$ of reading + 5 digits)
$10.0 \div 99.9$	0.1	
$100 \div 19999$	1	

Prospective fault current (calculated value)

Measuring range (A)	Resolution (A)	Accuracy
$0.00 \div 9.99$	0.01	Consider accuracy of fault loop impedance measurement
$10.0 \div 99.9$	0.1	
$100 \div 999$	1	
$1.00k \div 9.99k$	10	
$10.0k \div 23.0k$	100	

The accuracy is valid if mains voltage is stable during the measurement.

IPSC calculation: IPSC = $U_N \cdot k_{SC} / Z_L - PE$
 $U_N = 55 \text{ V}$; ($44 \text{ V} \leq U_{inp} < 61 \text{ V}$) for selected 55 V single-phase system
 $U_N = 63 \text{ V}$; ($56 \text{ V} \leq U_{inp} < 70 \text{ V}$) for selected 63 V three-phase system
 Maximum loading 1.9 A / 10 ms
 Nominal input voltage 55 V / 63 V, 14 Hz ÷ 500 Hz
 Test possibilities L1 - PE and L2 - PE

RCD selected

Loop impedance

Measuring range according to EN61557 is $0.85 \Omega \div 19999 \Omega$.

Measuring range (Ω)	Resolution (Ω)	Accuracy *
0.00 ÷ 9.99	0.01	$\pm(10 \%$ of reading + 15 digits)
10.0 ÷ 99.9	0.1	$\pm 15 \%$ of reading
100 ÷ 19999	1	$\pm 20 \%$ of reading

* Accuracy may be impaired in case of heavy noise on mains voltage

Prospective fault current (calculated value)

Measuring range (A)	Resolution (A)	Accuracy
0.00 ÷ 9.99	0.01	Consider accuracy of fault loop impedance measurement
10.0 ÷ 99.9	0.1	
100 ÷ 999	1	
1.00k ÷ 9.99k	10	
10.0k ÷ 23.0k	100	

IPSC calculation: IPSC = $U_N \cdot k_{SC} / Z_L - PE$
 $U_N = 55 \text{ V}$; ($44 \text{ V} \leq U_{inp} < 61 \text{ V}$) for selected 55 V single-phase system
 $U_N = 63 \text{ V}$; ($56 \text{ V} \leq U_{inp} < 70 \text{ V}$) for selected 63 V three-phase system
 Nominal input voltage 55 V / 63 V, 14 Hz ÷ 500 Hz
 Test possibilities L1 - PE and L2 - PE
 No trip out of RCD.
 R, XL values are indicative.

E.4.3 Line impedance and prospective short-circuit current

 $Z_{\text{Line-Line}}$

Measuring range according to EN61557 is 0.25 Ω ÷ 19.9 k Ω .

Measuring range (Ω)	Resolution (Ω)	Accuracy
0.00 ÷ 9.99	0.01	±(5 % of reading + 5 digits)
10.0 ÷ 99.9	0.1	
100 ÷ 999	1	
1.00k ÷ 9.99k	10	
10.0k ÷ 19.9k	100	

Prospective short-circuit current

Measuring range according to EN61557 is 0.25 A ÷ 440A (ksc = 1)

Measuring range (A)	Resolution (A)	Accuracy
0.00 ÷ 0.99	0.01	Consider accuracy of line impedance measurement
1.0 ÷ 99.9	0.1	
100 ÷ 999	1	
1.00k ÷ 99.99k	10	
100k ÷ 199k	1000	

*The accuracy is valid if:

Mains voltage is stable during the measurement

IPSC calculation: IPSC = $U_N \cdot k_{sc} / Z_{\text{Line-Line}}$

$U_N = 110 \text{ V}; (90 \text{ V} \leq U_{\text{inp}} < 121 \text{ V})$

Maximum loading 3.1 A / 10 ms

Nominal input voltage 110 V, 14 Hz ÷ 500 Hz

R, XL values are indicative.

